

# EIR

Executive Intelligence Review

October 25, 2019 Vol. 46 No. 42 [www.larouchepub.com](http://www.larouchepub.com) \$10.00

## Personal Leadership in a Moment of Crisis





Founder: *Lyndon H. LaRouche, Jr. (1922–2019)*  
Editor-in-Chief: *Helga Zepp-LaRouche*  
Co-Editors: *Marcia Merry Baker, Paul Gallagher,*  
*Robert Ingraham, Tony Papert*  
Managing Editor: *Stephanie Ezrol*  
Editorial Staff: *David Cherry, Charles Notley*  
Technology: *Marsha Freeman*  
Transcriptions: *Katherine Notley*  
Ebooks: *Richard Burden*  
Graphics: *Alan Yue*  
Photos: *Stuart Lewis*  
Circulation Manager: *Stanley Ezrol*

#### INTELLIGENCE DIRECTORS

Asia: *Michael Billington*  
Economics: *Marcia Merry Baker, Paul Gallagher*  
History: *Anton Chaitkin*  
Ibero-America: *Dennis Small*  
United States: *Debra Freeman*

#### INTERNATIONAL BUREAUS

Berlin: *Rainer Apel*  
Copenhagen: *Tom Gillesberg*  
Lima: *Sara Madueño*  
Melbourne: *Robert Barwick*  
Mexico City: *Gerardo Castilleja Chávez*  
New Delhi: *Ramtanu Maitra*  
Paris: *Christine Bierre*  
Stockholm: *Ulf Sandmark*  
United Nations, N.Y.C.: *Richard Black, Leni Rubinstein*  
Washington, D.C.: *William Jones*  
Wiesbaden: *Göran Haglund*

#### ON THE WEB

e-mail: [eirms@larouchepub.com](mailto:eirms@larouchepub.com)  
[www.larouchepub.com](http://www.larouchepub.com)  
[www.executiveintelligencecereview.com](http://www.executiveintelligencecereview.com)  
[www.larouchepub.com/eiw](http://www.larouchepub.com/eiw)  
Webmaster: *John Sigerson*  
Assistant Webmaster: *George Hollis*  
Editor, Arabic-language edition: *Hussein Askary*

---

EIR (ISSN 0273-6314) is published weekly  
(50 issues), by *EIR News Service, Inc.*,  
P.O. Box 17390, Washington, D.C. 20041-0390.  
(571) 293-0935

**European Headquarters:** E.I.R. GmbH,  
Bahnstrasse 4, 65205, Wiesbaden, Germany  
Tel: 49-611-73650  
Homepage: <http://www.eir.de>  
e-mail: [info@eir.de](mailto:info@eir.de)  
Director: Georg Neudecker

**Montreal, Canada:** 514-461-1557  
[eir@eircanada.ca](mailto:eir@eircanada.ca)

**Denmark:** EIR - Danmark, Sankt Knuds Vej 11,  
basement left, DK-1903 Frederiksberg, Denmark.  
Tel.: +45 35 43 60 40, Fax: +45 35 43 87 57. e-mail:  
[eirdk@hotmail.com](mailto:eirdk@hotmail.com).

**Mexico City:** EIR, Sor Juana Inés de la Cruz 242-2  
Col. Agricultura C.P. 11360  
Delegación M. Hidalgo, México D.F.  
Tel. (5525) 5318-2301  
[eirmexico@gmail.com](mailto:eirmexico@gmail.com)

Copyright: ©2019 EIR News Service. All rights reserved. Reproduction in whole or in part without permission strictly prohibited.

Canada Post Publication Sales Agreement  
#40683579

**Postmaster:** Send all address changes to *EIR*, P.O. Box 17390, Washington, D.C. 20041-0390.

Signed articles in *EIR* represent the views of the authors, and not necessarily those of the Editorial Board.

# Personal Leadership In a Moment of Crisis

## EDITORIAL

---

# The Hour Has Struck

by Tony Papert

Oct. 17—In most periods, history allows little change for the better over the short term, and the wisest minds patiently prepare for the opportunities which the future will present. Then come those other, rarer times where decades or longer are thrown into the balance over mere weeks or days—revolutionary times.

LaRouche PAC's stirring video interviews just released with Hussein [Askary](#) and Virginia State Senator Richard [Black](#) demonstrate that these are indeed revolutionary times. Now that President Trump is finally free to fulfill his campaign promise to extract the United States from the endless, no-win wars of Bush and Obama, and instead to negotiate peace with Russia and all other parties, a revolution of hope is being launched. Hope has seized the Middle East—and the Americans who elected him President for that reason, along with many who did not vote for him. (At this moment when Gallup lies that 52% of Americans want President Trump impeached and removed from office.)

Now, Americans are called on to expose and defeat the treasonous impeachment farce, and *EIR* will continue to expose all the lies and dirty intelligence operations behind it—all of them committed ultimately on the orders of the financier-oligarchs centered in the City of London, such as the Governor of the Bank of England, Mr. Green Finance, Mark Carney.

But the living legacy of the late American genius Lyndon LaRouche tells us that we must go further, and we must do it now. The task is more than just overcoming geopolitics, nor is it possible to simply stop there. The present situation is a unique opportunity to ground

peace in economic recovery and economic reconstruction of America and of the world.

It was just such an opportunity that Lyndon LaRouche saw in the collapse of the European communist (Warsaw Pact) system over the years 1989-1991. He seized on the opportunity he saw, even if almost no one else saw it clearly then, to overcome economic decay in the West and Eastern Europe, while simultaneously making development possible in the so-called Third World. He fought tenaciously, even from the prison cell where he was unjustly confined, to bring this about. As one man, with his wife and a few friends, he carried this battle to every continent. He saw allies assassinated, like German banker Alfred Herrhausen—but he fought on. It took the combined forces of UK Prime Minister Thatcher, U.S. President George H.W. Bush and French President François Mitterrand to defeat this one man's initiative for what he had named the "[European Productive Triangle](#)." It was a vast infrastructural plan to tie together the most productive centers of Europe, launch high-technology development there, and spin it off into Eastern Europe, Asia and beyond.

He lost then, but the idea he championed was adopted as China's policy by her new President, Xi Jinping, in 2013, after many years of prior discussion in China inspired by Lyndon and Helga LaRouche. In just the past six years, it has profoundly changed the world, among other things bringing never-before-seen hope to Africa.

Now we face an even greater opportunity. The forces which crushed LaRouche's plan then still exist,

but they are vastly weaker, and they are off balance. The opportunity is here for the twenty-first century version of Franklin Roosevelt’s recovery plan, which Lyndon LaRouche expounded in his “[Four Laws](#)” and elsewhere. Internationally, the opportunity exists now (and for how long?) for the great powers of the United States, Russia, China and India to create a new credit system geared for world high-technology development, featuring massive capital exports from the developed

sector to the underdeveloped, made possible by long-term, low-interest loans under a gold-reserve dollar system of relatively fixed exchange rates.

This can be done now—the forces exist. And it must be done now. Whatever your favorite media may or may not be telling you and your contacts, the financial crisis is in process of breaking out. The only answers lie along the directions LaRouche has plotted out. Take heed!

## Syria: How President Trump Outflanked the Permanent War Party

*Two exclusive interviews on this revolutionary development*



**RICHARD BLACK**  
VIRGINIA STATE SENATOR (R-VA DISTRICT 13)

An exclusive interview with Virginia State Senator Richard Black

[WATCH THE INTERVIEW](#)



**HUSSEIN ASKARY**  
EIR ARABIC EDITOR

An exclusive interview with Hussein Askary, EIR Arabic Editor

[WATCH THE INTERVIEW](#)

## Cover This Week

*Russian President Vladimir Putin (center) meeting with the President of Chechnya Alu Alkhanov (left) and First Deputy Prime Minister of Chechnya Ramzan Kadyrov (right) in Grozny on December 12, 2005.*



kremlin.ru

### PERSONAL LEADERSHIP IN A MOMENT OF CRISIS

2 EDITORIAL

#### **The Hour Has Struck**

by Tony Papert

### I. How to Change History

#### **5 The LaRouche Gold Proposal: Averting Economic Depression**

National Democratic Policy Committee

September 22, 1981

10 ZEPP-LAROCHE WEBCAST

#### **The Secret of How Trump Outflanked the War Party**

17 **In Syria, the Peace Plan Is Underway**

by Hussein Askary

### II. Will Promethean Science Prevail?

18 WHILE NASA MOVES FORWARD

#### **Moon-Mars Mission Challenged by Democrats' Impeachment Fixation**

20 **Study Opens Way for Crash Program Joining Space Travel to Fusion Power**

by Paul Gallagher

22 **Mining Helium-3 on the Moon**

by Aaron Olson

31 **MARK CARNEY'S RAMPAGE More Scientists Reject Climate Hysteria as Bank of England Screams Bloody Murder**

### III. Our Russian Partner

33 VALDAI DISCUSSION CLUB PLENARY

#### **Vladimir Putin: 'Global Problems Cannot be Resolved Without Asia'**

40 **Russia Rules Against Carbon Emission Penalties**

**The Jan. 27, 1989 Jailing of Lyndon LaRouche Defined an Era, Which Now Must End**

[Watch The LaRouche Case](#) video

[Watch the LaRouche Memorial](#) video

[Sign the Petition to Exonerate LaRouche](#)  
at [lpac.co/exonerate](http://lpac.co/exonerate)

---

# I . How to Change History

---

SEPTEMBER 22, 1981

## The LaRouche Gold Proposal: Averting Economic Depression

*Editor's Preface: Today, when the world stands on the verge of a plunge into financial crisis, Lyndon LaRouche's [Four Laws](#) and his proposed [New Bretton Woods System](#) point to the only direction for economic recovery. Because a background in LaRouche's economic thinking is required to comprehensively understand and implement such measures, we reprint below a proposal of his from 1981, to help start that thinking process among our readers.*

The National Democratic Policy Committee under the direction of Advisory Board Chairman Lyndon LaRouche, issued the following urgent resolution on gold policy on Sept. 22, 1981.

Even at this late hour, the re-introduction of gold into the world monetary system can prevent a major financial crisis and economic depression. The Federal Reserve's incompetent, destructive monetary policy has already pushed the U.S. economy into the second stage of a depression that began immediately after Chairman Volcker's "Saturday Night Massacre" of Oct. 4, 1979. Between now and year-end, unless appropriate countermeasures are adopted, the U.S. financial system will endure a liquidity crisis on a scale worse than that of 1929-33.

This is a war for the survival of the United States, not—as the Fed has argued—payment for the past sins of largesse committed by previous Administrations. America's banking system is already under the dictatorial control of the "offshore" money markets, which the



Stuart Lewis

*Lyndon LaRouche in a San Francisco press conference in 1984.*

Fed has transformed into the only source of liquidity available to American borrowers. Remonetization of gold is the step required to win the war on behalf of American productivity and living standards.

Step one is to remove the gold issue from monetarist incantation over "market perceptions," "inflationary expectations," and "monetary control." Those disciplines which the American financial system requires may be reduced practicably to a single overriding constraint: we must restrict the expansion of credit to those uses which will improve productivity, output, and exports. That is, we must do the opposite of the Federal Reserve's sup-

---

**Editor's note:** This is a reprint from EIR, Vol. 8, No. 40, Oct. 13, 1981, pages 18-21.

posedly “restrictive” program, which has added \$25 billion per year to federal debt-service costs and deficit-financing needs, and a debt-service burden to the private sector that forced a 35 percent annual rate of credit expansion during the first eight months of this year.

The proper use of gold is to build such a constraint into our financial system, through our financial relations with other nations. The specific measures required to bring about this arrangement are straightforward and clearly understandable to a majority of the American population, once we agree that monetary controls exist to address the real problem, the state of the economy’s productive base.

Below, we outline the requirements of a return to gold-based monetary stability, and explain why the competing monetarist versions of the gold standard have no hope of success.

**1) Remonetize American Treasury gold reserves at \$500 per ounce or the market price, whichever is higher.**

In current capital-goods and labor costs, \$500 per ounce is the marginal price of gold, i.e., the price at which new gold mines may be brought into production on sufficient scale to assure an adequate supply of new monetary gold.

**2) Establish the value of the U.S. dollar as a fixed weight of gold, e.g., one-five hundredth Troy ounce of gold, and agree to exchange gold in payment for current account deficits or surpluses with nations who follow a similar monetary policy.**

By agreeing to exchange gold with nations to balance our current account payments (merchandise trade plus shipping, insurance, tourism, and similar services), we are making a commitment to pay our own way in international trade.

However, we will do this only with nations that adopt the same program. In practice, there is little question that most of the nations that now belong to the European Monetary System, a gold-reserve and fixed-currency agreement among the eight leading European countries, as well as Japan, would join such an agreement enthusiastically.

By making the dollar as good as gold on international markets, this action would immediately bring down interest rates, by eliminating hundreds of billions of dollars in currency speculation and hedging in foreign markets, which consumes the biggest portion of credit generated worldwide.

**3) Issue a new series of U.S. Notes against our gold reserve, through participations in productive-investment credits in the banking system.**

To make good our promise to pay gold to cover our international accounts with our trading partners, we must simultaneously ensure that the credit we issue at home expands productivity and output. At present the Federal Reserve “prints money” by adding funds to the New York money market, i.e., to the large international banks. Under this system the American banking system opened up \$49 billion in credit lines for inflationary, speculative corporate takeovers, but lent on net virtually nothing to basic industry.

The Federal Reserve’s method of creating credit is inflationary. We propose, instead, to return to the monetary policy of the Lincoln administration—U.S. Notes issued for productive purposes, and backed by America’s ability to back the dollar with gold.

Instead of an independent agency with unlimited discretionary powers to create money, the Federal Reserve should be reduced to a mere agent of the U.S. Treasury, by amendment to the Federal Reserve Act. All discussion at the Federal Reserve or otherwise about “monetary targets” and “desired rates of money growth” at the Federal Reserve or elsewhere is pure bunk. We can create as much credit as we want, provided that Americans can absorb it into new investments in industry, agriculture, mining, construction, and transportation, i.e., activities that add to the nation’s tangible wealth.

The Treasury will lend out U.S. Notes at 6 percent interest for investment or working-capital purposes in manufacturing, agriculture, mining, construction, and transportation, according to this procedure: any private banker may apply to the local Federal Reserve banks, acting as the Treasury’s agents, for a U.S. Notes *participation* in a credit for these designated areas. Only when a private corporation will initiate such investment, and a private bank will take at least half the credit risk, will the Treasury issue U.S. Notes.

There is no great complexity or threat of bureaucracy in this program. Presently, local bankers have to turn to the mirror-world of the money centers, e.g., overnight repurchase agreements, federal funds, correspondent loans, and so forth to raise funds, and turn their operations upside-down with every new patch of regulation or “deregulation” introduced by the Fed or Congress. We will reduce bankers’ sources of funds to



two: deposits generated by business activity in their localities, or direct infusions of low-interest loans of U.S. Notes where required.

Although monetarists will throw up their hands at a distinction between “productive” and “nonproductive” credit, despite the insistence upon such a distinction in all economics up through and including Adam Smith and David Ricardo, every local banker will understand precisely what is involved. Any intelligent banker knows that certain types of business put “real tax-base” into a community, e.g., manufacturing, agriculture, and mining. He knows that a community which invests exclusively in fast food restaurants, high-rise office towers, and the other staples of the late 1970s U.S. economy will go broke.

Gold backing for this credit issue constitutes a basic discipline on our actions. America’s slippage into trade deficit during the 1970s is a consistent and accurate measure of our declining productivity, brought on largely by the malfeasance of the Federal Reserve. Correction of these policies and restoration of our productivity growth will also revive our export potential; otherwise our gold will flow out to foreign nations.

#### **4) Prevent inflationary credit from undermining the U.S. Notes program.**

The principal source of inflationary credit in the U.S. economy is not the “printing-press” money of the Federal Reserve but the accumulated “book-money” of the Eurodollar market. With no reserve requirement, the foreign branches of the Wall Street banks, along with the British and Canadian international banks, create unlimited book-credits among each other. This \$1.5 trillion mass of fictitious paper is the world’s principal source of inflation. Inflows of Eurodollar book-credit account for virtually all the speculative credit lines for corporate takeovers in the U.S.

Monetary inflation can be eliminated overnight by two simple, long-overdue measures:

- 1) The Federal Reserve shall cease to be a net issuer of credit, and act only as the Treasury’s transfer agent for U.S. Notes. U.S. Notes will gradually replace the unconstitutional issue of Federal Reserve notes as circulating currency of the United States of America.

- 2) The Treasury shall institute a policy of *transparency of sources of credit* to prevent the influx of inflationary, Eurodollar book-credits. One rule will suffice: as a matter of simple banking safety, no substandard

paper will be permitted to circulate in the American banking system. A Eurodollar loan to an American company is a right to draw on a Eurodollar account unbacked by any reserves, contrary to American banking law. No such fictitious money may be lent into the United States, period.

Such action will immediately break the stranglehold over world credit now exercised by the Anglo-Canadian banking cartel, the main beneficiary of the Federal Reserve’s unconstitutional policy of money issue.

#### **5) Except for participations in productive credits, the Treasury will create U.S. Notes on only one other condition, to buy gold from U.S. citizens presented to the Treasury.**

The Treasury will buy such gold at the price fixed at the outset of such a program.

#### **6) The United States and other nations participating in this gold-reserve system will trade gold among each other at a fixed price, regardless of the behavior of the free market price. No U.S. monetary policy shall be subject to the whims of gold speculators.**

Since the basis for determining the fixed price of gold is the required production-price of new gold supplies, this price fixing will endure—provided that credit issue contributes to anti-inflationary gains in productivity. Any attempt by speculators to push the price above the level at which central banks exchange gold among each other might, temporarily, produce a “two-tier” gold price of the type seen between 1968 and 1971. However, we have no doubt who would come out the victor in this sort of economic war.

The flaw in the various monetarist proposals for gold restoration (e.g., Laffer, Lehrman, Wanniski, Ron Paul) is elementary. The United States must conduct a form of economic warfare against an international financial cartel whose principal objective is to have the carcass of the U.S. economy to pick over. Their ally is the Federal Reserve, and their chief operator is Federal Reserve Chairman Paul Volcker. Without the two fundamental safeguards described above, i.e., *transparency of sources of credit*, and *priority for productive credits*, the United States monetary authorities will have little say in the management of the monetary system relative to the London and Cayman Islands offshore centers. Either, as the Federal Reserve proposes, the monetary authorities will bring about a deflationary collapse of the credit system by tightening credit to pre-

vent gold outflow, or the U.S. will simply lose its gold stock to speculators.

By making the dollar “as good as gold” through the above plan, the United States can return to international economic pre-eminence.

## Questions About the LaRouche Proposal

*Below are replies, provided by Richard Freeman for the October 13, 1981 EIR, to the then most frequently asked question about the LaRouche gold proposal.*

**Q:** Which specific agency, authority, or special committee shall make the decisions as to which are the productive and which are speculative investments? In other words, who decides where the gold-based notes go?

**A:** The specific agency is the Federal Reserve Board of Governors, based in Washington, D.C. But the Federal Reserve will be changed, by an amendment of the Fed Act—passed by Congress—into the status of a mere agency within the U.S. Treasury. Therefore, the Treasury Department will make the final decision.

**Q:** What volume of gold-based notes is foreseen?

**A:** The LaRouche proposal proposes to freeze the level of U.S. Federal Reserve notes in circulation—currently \$125 billion—at its present level. It will then increase the money supply solely through the mechanism of Federal Reserve issuance of gold-based currency notes for loans for productive purposes. The Fed will cease creating new currency through any other procedure, including monetizing the Treasury debt.

**Q:** What happens to credit issuance before your new system has taken effect?

**A:** Nothing. Unlike the proposal of Art Laffer, the LaRouche proposal does not plan to have a waiting period of a year or more, to determine the “free-market” price of gold. The idea of a “free-market” price of gold for a government gold system is ridiculous. Governments, by treaty agreement, will set the price of gold, and therefore, the system can go into effect immediately. One day there will be one system of credit issuance, the next day the LaRouche system.

**Q:** Explain in detail the international exchange of accounts. How would bilateral trade work?

**A:** The United States will settle its accounts with its bilateral trading partners in gold. This means whichever of the two countries, the U.S. or its trading partner, runs a current-account deficit at the end of the year (that is, a deficit on trade, insurance, freight, tourism and other invisibles) will remit the amount of that deficit in gold to the country it is in deficit to. By the end of the year, all current-account imbalances will be squared away.

**Q:** Is LaRouche proposing the creation of a new international financial institution based on the use of gold?

**A:** Yes. LaRouche has long been of the view that the world financial system is troubled by the uncontrolled Eurodollar market, now totaling over \$1 trillion, and by the overhang of \$500 billion of non-oil-producing third world indebtedness, the bulk of which is nonperforming. Therefore he has proposed an international gold-based fixed exchange monetary system, in which currencies are set in parity bands relative to one another; and the creation of a new international credit-issuing banking institution based on the use of gold.

The basic principle of the new bank is that it would reorganize world debt, and issue gold-denominated new currency notes as the terms of the new loans. The interest rate on the loans would be 2 to 4 percent.

First, the bank will acquire its currency at the time that the charter creating the new banking institution is adopted. Deposits will consist of gold-reserve currency notes of sovereign nations deposited at the bank, for which the sovereign nations, such as the United States, will receive stock subscription in the new bank. Against this pool of notes, the new bank has the collateral to issue its own gold-denominated currency notes.

New loans by the new bank will be made to any nation or economic entity that has signed the treaty creating the new bank. The loans are made by the new bank essentially as *discounts on loan agreements between participating members of the new bank*.

An importing nation, say Brazil, would contract a loan with Germany, for example, or with a German exporting agency and that agency’s bank. Once the loan is determined to be for productive purposes, Brazil would submit that loan to the new bank, asking that bank to discount either part or all of the loan. This means that the new bank, after examining the loan itself, would make available to the German exporting agency’s bank

either all or some of the value of the loan in gold-denominated currency notes at 2 to 4 percent interest rate. This money is then lent by the Germany exporting agency's bank to Brazil.

**Q:** Which nations would participate immediately in this new gold-based monetary system, and why? What about the Third World?

**A:** The leading eight European nations of the gold-based European Monetary System, most importantly Germany, as well as Japan, which bought 68 tons of gold this July alone, would be more than glad to join the United States immediately in a world gold-based system. These nations and the United States combined have large enough gold reserves to make the system work and preserve its integrity.

The Third World nations would be encouraged to join. If they were low on gold reserves, they would pledge future productive capacity for goods production as security for their loans. A redistribution through open-market sales of gold reserves could be easily conducted to provide Third World nations with ample gold to conduct their current-account settlements.

**Q:** How does the LaRouche proposal help to dry out the enormous liquidity being wasted by corporate mergers, money-market funds, and the Eurodollar market?

**A:** The Eurodollar market is like an international "crap game" in that it sloshes around the world, controlled by no national government and swelling the money supply of key nations, especially America's. The Eurodollar market creates a mass of fictitious paper values; it is the major cause for double-digit U.S. inflation. Corporate mergers, which totaled \$34 billion in the first six months of 1981, are nonproductive, but as you suggest suck up a tremendous amount of liquidity.

The LaRouche proposal begins with the distinction of productive versus nonproductive and inflationary forms of economic activity. The Fed will reward loans to productive industry, by agreeing, under the LaRouche proposal, to take participation in any private commercial-bank loan that the private bank makes to manufacturing, mining, construction, transportation, or agricultural entities. The Fed will participate by agreeing to discount up to 50 percent of any private bank loan it deems worthy. The private bank must risk its assets

for the other 50 percent of that loan. The Fed will issue to the private bank up to 50 percent of the value of any productive loan in gold-based U.S. currency notes at interest rates of 2 to 4 percent.

On the other hand the Fed will refuse to make credit available for nonproductive, speculative, wasteful or overhead loans except at the prevailing free-market rate, which is now 19.5 percent. Under these conditions, banks will choose to make productive loans. The spread on the difference between what a bank can earn when it pays 2 to 4 percent for its money and when it pays 19 percent, is enormous, even if the productive investments have lower profit margins.

A bank knows that if it relends the money it got from the Fed at 4 percent for 6 percent interest, it will get its earnings back, because the investment will produce a real-wealth profit. Individual investors, having to pay correspondingly higher interest rates if they borrow from a bank for non-productive purposes, will also choose to invest in productive investments.

And the Euromarkets will dry up as soon as the new treaty agreement is signed. Under this agreement, no bank will be permitted to lend dollars, unless the loan conforms to the terms of the treaty, and that includes meeting reserve requirements. Most Eurodollar banking thrives on its reserve-free status.

The speculative outlets that are the chief lending objects for the Eurodollar market will be dried up. Very soon, all international lending will take place in gold-denominated currency notes—these will be the only type that governments and private institutions and individuals will want to hold. All non-gold-secured dollars that are not earmarked for productive loans will not be discounted internationally by the new lending bank, and will not be trusted by private investors.

**Q:** Why doesn't the issuance of new LaRouche gold-based currency notes add to the money supply?

**A:** It will add to the money supply; however, this will be a noninflationary increment. Each new increment in credit, C, will be lent to industry or agriculture to increase its absolute surplus or overall profit. Insofar as overall profit grows faster than C, then goods production is exceeding money supply, and that is noninflationary. Moreover, since the new productive loans generate will go primarily to industries employing high technology, the cost of production will decline, and that is in fact *counterinflationary*.

# The Secret of How Trump Outflanked the War Party

*This is the edited transcript of the Schiller Institute's October 18, 2019 New Paradigm interview with the founder of the Schiller Institutes, Helga Zepp-LaRouche, by Harley Schlanger. A [video](#) of the webcast is available.*

**Harley Schlanger:** Hello, I'm Harley Schlanger from the Schiller Institute. Welcome to our webcast this week, with our founder and President Helga Zepp-LaRouche; today is October 18, 2019.

There have been very fast-moving and significant developments this week; in Syria, China, and on the political scene in the United States. Helga, I think it's quite significant now that President Trump is having a series of rallies to get across his message, since the mainstream media do not intend to let him have his say. How do you see these rallies, playing into shifting the situation in the U.S. population?

## Mainstream Media Deceive and Distort

**Helga Zepp-LaRouche:** The mainstream media, both in the United States and in Europe, are absolutely not reporting what Trump is doing. They are bringing a completely distorted picture which can only be characterized as a conscious campaign to deceive the population, concerning his announcement of pulling U.S. troops out of Syria.

I mean, these are not media, these are Public Rela-

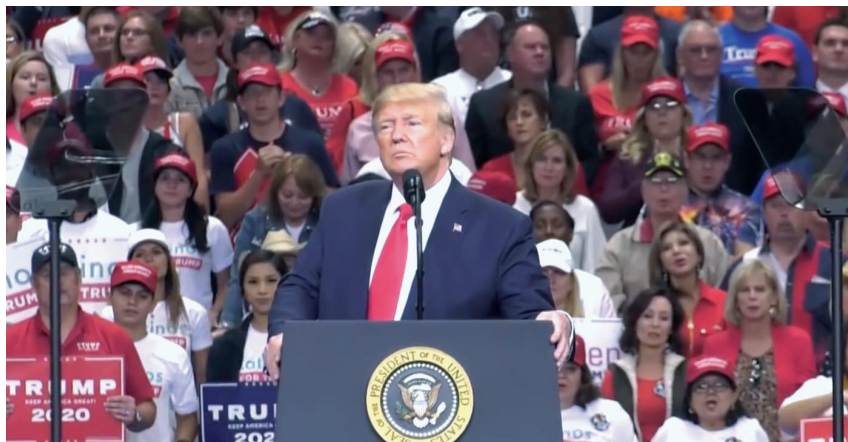

Donald J. Trump page

*President Trump addresses a campaign rally in Dallas Texas on October 17, 2019.*

tions (PR) firms run by intelligence agencies to change the axioms of the population: That's what it is. Because there is no bigger discrepancy between what Trump is doing, together with Putin, which is really absolutely crucial for world peace, and the picture you get from these media.

So, in these rallies as in the press conference at the White House on October 16 with the Italian President Sergio Mattarella, Trump repeated the same story,

namely that it's time to pull the U.S. soldiers out of these endless wars, that the United States has no intention to continue to police the world in 90 countries around the globe, and that that should be ended.

Now, people should be happy about that! Because all of this was very clearly done in coordination with Russia. And if you want to end the misery in the Middle East countries, terrorism, endless wars, it is very, very clear that only if the United States and



Turkish Presidency

*Vice President Mike Pence and Turkish President Recep Tayyip Erdoğan.*

Russia, and China are working together, that you can solve this problem.

So, to repeat again, all of the media barrage that the ceasefire that Vice President Mike Pence negotiated with President Erdoğan of Turkey is not working is just not true.

The Kurds in the northeast have agreed to work with the Syrian government and give up their heavy weapons. Turkey had agreed to this approach and is no longer insisting on regime change against the Assad government. While not every Kurd will immediately agree to a ceasefire in such a region, so there will be interruptions and skirmishes, but by and large the ceasefire is working. Erdoğan, after meeting with Pence and Secretary of State Mike Pompeo, is now scheduled to go to Sochi, Russia on October 22, where, according to Russian Foreign Minister Sergey Lavrov, the political solution in this region and in Syria, including the Constitutional Council that will meet in Geneva, will be discussed with Erdoğan. So all the signs are that this will function.

People have such a short memory: The whole trouble really started with Obama, and people forget that. In 2015, Putin militarily intervened in Syria, and really resumed Russia's role as a key player on the world stage, which Obama had denied by saying Russia is only a "regional" force and regional player. At that time Putin had asked the United States to cooperate in calming down the situation in Syria, which Obama had explicitly refused, and instead had the CIA arm the jihadists in the northeast of Syria, working with the same people who had been involved in 9/11. This was the problem. And now, Trump and Putin are

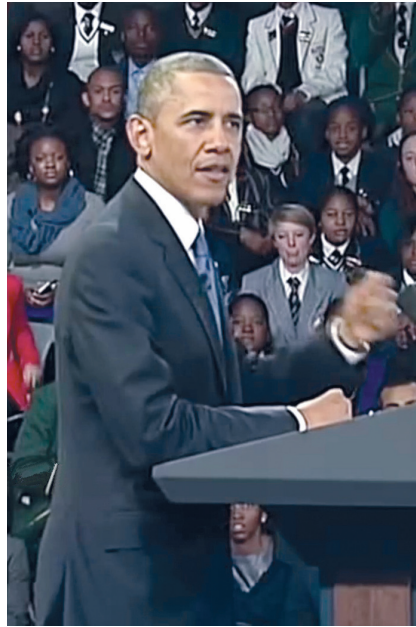

White House  
*Former President Barack Obama in South Africa in 2013.*

cooperating to undo this, and also working with all the other countries in the region towards a settlement.

## Reconstruction for Middle East Peace

So, people should be happy about that! This is a world-historic change, ending the interventionist wars, ending the humanitarian right-to-protect pretext to violate sovereignty, to go for regime change: *This is really, very, very important news.* And it just shows you how malicious the media are and how brainwashed people are, that they no longer can recognize a peace policy when it is happening in front of their eyes.

The very big question now is the reconstruction. I think the spokeswoman for the Russian Foreign Ministry, Maria Zakharova, was quite right, when she blasted the European Union, which had criticized Erdoğan for making the military incursion into Syria. So, Ms. Zakharova basically said, the Europeans have no role in this at all, they should help the children, or do fundraisers, but they should otherwise stop just giving press conferences because they have no role.

What is now needed is the reconstruction of Syria, to start with. Estimates are that at least \$200 billion will be needed, probably more. And the only way that can be done, is that the New Silk Road—the Belt and Road Initiative—be extended into Syria, and that there be a division of labor between Russia, Iran, and also China. Other countries should help: The Europeans should stop complaining and should give up their opposition to Assad, as clearly their operation has not succeeded in toppling Assad, so they should now draw the lesson and help with the



CC/Bo yaser  
*Massive destruction in the Bab Dreib area of Homs, Syria.*

reconstruction, but stay out of political meddling.

**Schlanger:** There are a couple points you just covered that I'd like you to just add to, a little bit: One is, what Trump is explicitly saying that he's allowing nations to be sovereign. He asks, what's wrong with Syria controlling Syrian territory? This obviously fits in with how these larger powers, Russia and the United States, can defend the sovereign rights over other countries, instead of violating those rights. Don't you think this is a pretty big deal, ending the era of interventions?

### A New Spirit of National Sovereignty ...

**Zepp-LaRouche:** Putin delivered a very interesting speech on October 3 at the 16th Annual Meeting of the Valdai Discussion Club in Sochi, Russia. He emphasized the need to have a new order emerging based on sovereignty. [See the transcript of Putin's speech in this issue of *EIR*.]

The report by the Diplomatic Academy of the Russian Foreign Ministry in August, "Global Challenges 2019," which noted that the West has utterly failed in its policies of regime change against Venezuela, Syria, and Ukraine, but is still at it, by supporting "dissidents" in all these situations, is also quite relevant. The Hong Kong situation is still very hot.

But I think we are now at a point at which the idea that the West can go on with Francis Fukuyama's assertion that we now live in "the end of history" and that so-called liberal democracy has won, as he put it after the collapse of the Soviet Union—this assertion, which then led to this whole effort of regime changes, trying to topple governments with color revolutions, has itself now come to an end.

There is now a recognition of who is behind such policies. And there is a new will by nations to assert their sovereignty. Only the collaboration of sovereign countries, working together for a common good, like what the Belt and Road Initiative is actually doing right now, which has developed a new model of cooperation. That must be the kind of cooperation of the future, of sovereign nations working with each other to their

mutual benefit, and the role of the British Empire must come to an end, for good.

### ... Except in the U.S. Congress

**Schlanger:** One institution that doesn't get this principle of sovereignty is the U.S. Congress. They voted this week 354-60—nonbinding—to stop Trump from ending the war in Syria. Senate Majority Leader Mitch McConnell and House Speaker Nancy Pelosi are saying "all roads lead to Putin," that the decision by Trump is "destabilizing the region," is adding to the chaos. The fact is, that peace is breaking out! How does that add to chaos? And then we see the Congress esca-



White House/Lawrence Jackson

*President Barack Obama addresses a joint session of Congress, September 9, 2009.*

lating on the Hong Kong front.

What can you say about the U.S. Congress, Helga?

**Zepp-LaRouche:** I think they are the almost daily proof that the United States, at this point, except for what Trump is doing, is not a democracy, but a plutocracy. I think all of these Congressmen are on a very short leash of Wall Street and Pelosi's turn is the best example: At an earlier point she recognized that the Democrats are on a clear road to lose the election if they keep talking only about impeachment, when the voters want to hear about jobs, the economy, health care, and other questions of the physical economy; but then, after meeting in New York City with some of the top bankers there, she changed her view.

Both the mainstream media, as well as the political leadership of both parties have really changed in their

character, and they're really controlled by the intelligence agencies. Many of the same people who have been involved in a coup against Trump, with Russiagate for two years, and now the effort to shift to Ukrainegate, are the same people now voting against peace in Syria; they're voting for the escalation in Hong Kong. So you can really see that this war party is really what Trump denounced when he talked about the "military-industrial complex."

I think it's worth noting that the "military-industrial complex" which President Eisenhower warned against in his farewell speech at the end of his second term in 1961, is not exactly the same military-industrial complex of that time, but it has merged with what people normally, mistakenly call the "deep state." I'm saying "mistakenly," because this military-industrial complex should really be seen more as an Anglo-American intelligence apparatus, the arm of the British Empire which has gotten large parts of the U.S. establishment to agree to run the world as an empire, as a unipolar world.

So, the Congress is really in a terrible shape. They will learn the lesson in the upcoming elections, provided we get there—because there are still enormous dangers and tension to overcome between now and that time.

### Trump Supporters Open to LaRouche Ideas

**Schlanger:** In a series of large rallies, Trump has been referring back to his 2016 campaign promise that he would end these endless wars and saying that this is what the American people support. I know you've seen some of these rallies and you've read what he's saying. What's your assessment? Do you think that he is reaching the American people, in spite of the treachery of the media and the political leadership?

**Zepp-LaRouche:** Well, on the one side, he is. Some colleagues of ours in the United States deployed to the Dallas and Washington rallies. They report that our role is absolutely crucial: We had, for example, signs—body signs and other signs—"Why the Rush to Impeachment?" and "Why now?" People responded with "Yeah,



EIRNS

*LaRouche PAC organizing at a "Defend Trump" rally on the Capitol West Lawn, Oct. 17, 2019.*

because the Democrats know they can't beat him in 2020."

That is not the right answer. The reason is, that the financial system is crashing right now. In Washington, for example, people came to support Trump and to defend him against the danger of impeachment, but then, some congressman got up and said, "Yes, yes, stop the coup," and then proceeded to blast Russia! "Stand up against Russia."

Our organizers were telling people, "Look that is not Trump's policy. Trump just got a peace agreement in the Middle East *with Russia*. And he has said, it's a good thing to have a good relationship with Russia."

The population will not have an easy time, if they don't listen to the Schiller Institute and read our publications, because the mainstream media, even Fox TV, the so-called "pro-Trump" TV, they're ragingly anti-China.

### The Situation Is Dangerous

I can only say: We are in a really dangerous situation, despite very positive developments. Take this Tweet, for example, from so-called comedian Tom Arnold, referring to the large crowds at Trump's rally in Dallas—saying "Don't become too..."—I don't want to use low-level language, but he wrote that John F. Kennedy had large crowds, too. And he said that in the context of Trump appearing in Dallas.

This brings back to my mind the article in the British magazine, the *Spectator*, that appeared in January

2017, under the headline “Will Donald Trump be assassinated, ousted in a coup, or just impeached?” strongly suggesting that Trump has to be gotten out of the White House one way or another, through a coup, through impeachment, or even through murder.

So I think we should keep that in mind. We should also keep in mind where this was published. The mainstream media are really, absolutely in lock-step with this line.

Another example. There is a program on Germany’s second channel TV, called “Heute Show” (“Today Show”), which in the past had some funny slapstick and cute things; but the latest program was an *absolutely*—I mean, these people are not journalists, or comedians anymore; they were making absolutely brutal attacks, using the worst kind of language against Trump, all just to create an environment where people really think that Trump is the biggest monster on the planet. And obviously, all of this is the kind of orchestration in which intelligence operations, like an assassination, become absolutely credible.

So, I think this is a very dangerous situation. And all of this is fueled by the pending financial crash.

### No Chance of Regime Change in China

**Schlanger:** I want to get to the financial crash in just a second, but first, one more aspect of the strategic situation: the escalation against China, with Sen. Ted Cruz pretending he’s a ninja in the Hong Kong crowds. Sen. Marco Rubio continues his threats. The Congress is drafting new legislation on Hong Kong. This is also part of the danger. You mentioned regime change/color revolutions—that’s absolutely what’s under way in China right now, isn’t it?

**Zepp-LaRouche:** Well, I don’t think so. I think they would like to do that, and the situation in Hong Kong is indeed very dire; the effects on the Hong Kong economy are severe. But I don’t think there is any chance of a successful regime change in the People’s Republic of China. Because, despite the anti-China hysteria, don’t forget that the Chinese people are absolutely happy with their government.

I have been many times in China, and I’m not saying this because I read some newspapers, but because I have formed my own opinion about it. I was in

CNN World Africa Americas Asia Australia China Europe India Middle East United Kingdom LIVE TV Edition

## US Sen. Ted Cruz rips Beijing 'dictatorship' during Hong Kong visit

By Brad Lendon, CNN  
Updated 10:03 AM ET, Sat October 12, 2019

US Sen. Ted Cruz at the US consul general's residence in Hong Kong on Saturday. Cruz dressed in all black to support pro-democracy protesters.

**Hong Kong (CNN)** — US Sen. Ted Cruz on Saturday condemned China's handling of pro-democracy protests in Hong Kong, saying suppression of free speech in the territory showed fear from what he called a "dictatorship" in Beijing.

More from CNN  
S  
U  
T  
C  
G  
S  
E  
get  
fil  
n

China the first time in 1971 and have been there many times since. I have seen the incredible success of the Chinese economic model, which has brought prosperity to many people. It has alleviated poverty almost entirely—there are a couple of million people who still are in the process of being helped to get out of poverty.

Also, I think the West, rather than being so hysterical about China, people should start to think, why is it that the Chinese economic model has been so extraordinarily successful? Why is it that 130 nations work happily with China? Is it because it is a win-win situation for them? And why is it that the focus of the Chinese on innovation as the main motor of the economy, is so much more successful than profit-maximization, which is characteristic of the neo-liberal model? So rather than being in this campaign, being “nudged,” as Cass Sunstein would call it, with this idea of PR manipulation of the population, I think people should really think for themselves.

My best estimate is that all of the accusations of the think tanks, including a new one from the European Council on Foreign Relations warning that China is “coming in the back door” into Europe, and Germany is trading too much—I mean, these are all absolutely geopolitically motivated attacks; they have absolutely nothing to do with the reality of China.

People should be happy that China has provided



such a model of international cooperation, which, if we succeed in getting Europe and the United States in a mode of cooperation—for example in the reconstruction of Southwest Asia, or the development of Africa—this is the best way to overcome all of these problems. I think the reason why they go after Trump so much, is that Trump wants to have a good relationship with Russia, and as he has said many times, he also thinks the relationship with China is absolutely crucial; he calls Xi Jinping his “good friend”—about which the Chinese are a little bit doubtful at this moment, after this trade war.

But Trump wants to improve the relationship among these two large countries. And as we said earlier, between China and India, there is also now a very important rapprochement, so therefore, the stage to do what my late husband always said, since many years ago, that you need the cooperation of the four largest countries, the United States, Russia, China, and India, to overcome the relics of the British Empire; this is absolutely going in the right direction, and therefore people should really think about these matters, and not just repeat stupid lines by stupid reporters who are no longer reporters but are just agents of the intelligence community.

### Big Financial Crash Looming

**Schlanger:** I’d like to then bring up another aspect of the work of your late husband, Lyndon LaRouche: After the 2008 crash, he warned policy-makers to take the right steps, but the policy that came through Obama, the Federal Reserve and others, was a bail-out policy that built upon the erroneous axioms that led to the 2008 crash. Now the International Monetary Fund is reporting that, yes, in fact, the crisis has grown into an even bigger crisis.

How do you see this thing unfolding, especially now that we have this ongoing bail-out on the repo markets? Something big is coming up, isn’t it?



2019 IMF Annual Meeting, seminar on climate change, Washington, D.C.

IMF

**Zepp-LaRouche:** Well, all the signs are that the thing is exploding, and that all the measures by the Fed and the other central banks are not working. At their semi-annual conference, now in progress, the IMF has put out a strong warning that 40% of the U.S. and European corporate debt will detonate, if there is a recession.

Now, the “recession” as they call it, is in full motion. The real economy has turned down everywhere, and the \$50-\$100 billion overnight repo lending to the banks, to give them two weeks’ lending to buy bonds and Treasuries through the central banks—all of this is really not functioning, and therefore, we are sitting on an absolute powder keg. Even the IMF says that if there is a sharp downturn, like what happened in 2008, waves of bankruptcies could lead to a complete turmoil.

It is therefore all the more urgent to do exactly what Lyndon LaRouche has worked out so brilliantly: Go with his Four Laws—global Glass-Steagall, national bank in the tradition of Alexander Hamilton, new credit system in the form of a New Bretton Woods system, crash program to increase productivity through development of fusion power, international space research cooperation, and then work together with China, Russia and India on the new paradigm in the New Silk Road.

This policy package will solve the problems, very, very quickly: But we simply need more people to bring this into the public square. So, again, my call to you: don’t sit on the fence in an incredible moment like this. Join the Schiller Institute, contact us, spread

this program, and become active with us.

**Schlanger:** And one other area, where Lyn has proven to be absolutely prescient, and it's beginning to come out now from other people, is his emphasis on the British Empire as the source of the problem. The British system versus the American System; British intelligence, the Great Game, geopolitics—there have been some articles recently, Helga. What can you report?

### British Empire Depredations Continue

**Zepp-LaRouche:** Well, actually, I think it's very good when publications and organizations other than us, really look at the role of the British Empire. There are two articles right now in *Consortium News*, an online newspaper: [The first](#), by Pepe Escobar, who goes into the role of the Sykes-Picot Agreement of 1916, in manipulating the people of the Middle East, when the British and the French divided the land up in such a way that there would always be room for some ethnic or other conflict; and that the British Empire's depredations are not over at all, but can be seen in many places.

A [second article](#), "Legacy of British Empire Lurks Behind Today's Headlines," by John Wight, elaborates on Escobar's discussion.

Everyone should read these two articles. The false belief that the British Empire no longer exists is really one of these PR tricks. My husband, Lyndon LaRouche, frequently said, the British Empire is like a slime-mold. A slime-mold changes its color and outward appearance, but it remains a slime-mold. After the official British Empire ended, the idea of empire simply shifted to the combination of central banks, investment banks, hedge funds, insurance companies, and assorted multinational corporations—the world's major financial powers that have taken over to a large extent. That is what we see right now. The British Empire is now speaking with the voice of the Governor of the Bank of England, Mark Carney, who wants to decarbonize the world economy, and direct all investments into "green" technology, which would be the end of industrial nations, and result in depopulation on a large scale.

So if you think the British Empire no longer exists, you have fallen for PR tricks. But if you know how these things actually work, in terms of who is the

power, and whose power is now crumbling, that is indeed this financial arm of the British Empire, which is why we are in all of this trouble.

However, some people in many countries around the world, including President Trump, including people in Russia, China, and many other countries, are smarter than ever before, including world leaders. We have Xi Jinping, we have Putin, Modi, Trump, and that is a good thing. So people who have held to the belief that the British Empire is defunct, should start to think. Maybe they'll come to the right conclusions.

### Exoneration of Lyndon LaRouche

**Schlanger:** I think this review of the strategic crises and the financial crisis brings us to an important point, which is that the exoneration of Lyndon LaRouche is at the center of the strategic counter-coup: This a major initiative that addresses almost all of these problems. So, people should continue to join with us: Sign the [petition](#) on our website.

Helga, maybe you want to say something about that, because I think this is something that gets right at the heart about how to defeat this war party.

**Zepp-LaRouche:** Well, people should go to our LaRouche PAC website and watch the [documentary](#), "The Case for the Exoneration of Lyndon LaRouche."

This is an extremely important way to understand why the apparatus that went after my husband in the 1980s and in the '90s—Robert Mueller, William Weld, the FBI—is the same apparatus that covered up 9/11, the same apparatus now in the anti-China campaign, the same exact apparatus that is behind the coup against President Trump.

So, if you want to get the United States back on the track of being a republic, of being a temple of liberty, of a country that people are proud to be living in, then help with the exoneration of my husband. Spread this documentary, sign the petition, and help us to put all this on the agenda. Because it's not just a question of addressing and remedying past crimes against him, but it is eminently an issue that people have to have a clear mind to think through the solutions Lyndon LaRouche proposed, because without LaRouche's policies, I don't think we will be able to get out of this really big crisis. We are very close, so it's worth your effort. Look at the exoneration campaign, and join it!

# In Syria, the Peace Plan Is Underway

by Hussein Askary

*The following article is from the EIR Strategic Alert Weekly Newsletter, Vol. 33, No. 43. The Newsletter, published in four languages in Wiesbaden, Germany, is available at <https://abo.eir.de/strategic-alert-service/>.*

Oct. 21—Developments in Syria, in the two weeks since the announcement of the U.S. troop withdrawal, seem to be following a carefully orchestrated plan, to which only the top political and military leaderships of the United States, Russia, Turkey, and Syria are privy. Everyone else, including politicians and mass media in Europe and the United States, are left guessing, or are otherwise attempting to sabotage these positive developments.

On the military front, the Syrian government forces, known as the Syrian Arab Army (SAA), have been allowed to retake, without any fighting, important border areas and, for the first time since 2012, came in contact with the Syrian-Turkish border in the town of Ain Al-Arab. With the exception of that town, the SAA has been carefully avoiding contact with the Turkish army in areas which are considered part of the Turkish “safe zone” along the border, where Turkey has continued to bomb positions held by the Syrian Democratic Forces (SDF), an insurgent military formation created in 2015. However, after the October 17 agreement between President Recep Tayyip Erdoğan and Vice President Pence to enforce a ceasefire, the large-scale operations were stopped. The SAA and withdrawing U.S. troops have also avoided clashes.

It should be stressed that all the reports and hype in the media about the escaping of ISIS prisoners is fake news. In fact, these stories were first spread by the SDF to induce the West to intervene to stop the Turkish incursion. However, many of the prisons in Hasakeh and Qamishli are far from the Turkish military operations zone, and are likely to have come under the control of the Syrian government army. Only one camp for ISIS families in Ain Isa was affected by the fighting between the SDF and Turkish army.



*U.S. Vice President Mike Pence and U.S. Secretary of State Michael R. Pompeo hold a press conference in Ankara, Turkey on October 17, 2019.*

Intensive diplomatic activities are ongoing to secure immediate political discussions to end the crisis in Syria. On October 18, Secretary of State Mike Pompeo visited NATO headquarters in Brussels to give a briefing on the ceasefire agreement in northern Syria. Earlier the same day, he was in Israel to speak personally with Prime Minister Benjamin Netanyahu and assure him of the U.S. commitment to regional security. At the same time, a Russian delegation of Special Representative for Syria Alexander Lavrentiev and Deputy Foreign Minister Sergei Vershinin were in Damascus for top-level meetings, including with President Bashar al-Assad. The two Russians had met the day before with Erdoğan’s Presidential Adviser, Ibrahim Kalin, and Deputy Foreign Minister Sedat Önal in Ankara.

On the expiration date of the ceasefire, October 22, President Erdoğan and Russian President Vladimir Putin will meet in Sochi. On October 24, NATO defense ministers, including U.S. Defense Secretary Mark Esper, will meet to discuss Syria. Then in Geneva, on October 30, the Syrian Constitutional Committee is set to convene under UN auspices. These talks should pave the way for a final political settlement between the government of Syria and different opposition groups.

---

## II. Will Promethean Science Prevail?

---

WHILE NASA MOVES FORWARD

# Moon-Mars Mission Challenged by Democrats' Impeachment Fixation

Oct. 21—Democratic Congressman Jose Serrano from the Bronx, New York, stated at the Congressional [hearing](#) “on NASA’s Moon Landing Proposal,” October 16, that he will not allow the Trump Administration’s Moon-Mars mission, the Artemis program, to be funded at the level requested and required to get it done. Serrano is Chairman of the Commerce, Justice, Science and Related Agencies Appropriations Subcommittee, which marks up NASA’s budget.



Rep. Serrano's webpage  
*Rep. José Serrano (at the podium) with Sen. Chuck Schumer, in 2011.*

The White House and NASA have, according the subcommittee’s website, “submitted a \$1.6 billion budget amendment that intended to start the effort to advance the return of humans to the Moon by four years,” which would accelerate the [Artemis program](#) to meet the goal of a human return to the Moon by 2024. The Senate Appropriations Committee has marked up three-quarters of that increase thus far.

NASA had just announced a new leader for human exploration, Doug Loverro, and introduced revolutionary new space suits for the Moon phase of the Moon-Mars mission on October 15.

But Serrano “dismissed” that effort today, according to a report in the *Houston Chronicle*. He told NASA Administrator Jim Bridenstine at the hearing,

While all of us on this subcommittee would like to send the first woman astronaut into deep space, including to the surface of the Moon, we want to do so in a responsible way—from the perspectives of safety, cost, and likelihood of mission success. . . . I remain extremely concerned about

the additional cost to accelerate the mission to the Moon by four years. . . . I believe that it is better to use the original NASA schedule of 2028 in order to have a successful, safe, and cost-effective mission for the benefit of the American people and the world.

However, there has never been a “cost-effective” space mission, nor one “done in a responsible way.” Space missions like the Apollo Program

or the new Artemis program are *productivity-effective* by virtue of the science “driver” they provide for rapid technological innovation, and thus they pay for themselves multiple times, but over a longer time period than their preparation and launch.

As for the “original NASA schedule of 2028,” Serrano’s vanilla “talking points” would take us back to where we were until Trump took office: nowhere. Keith Cowing, editor of the *NASA Watch* website, is quoted in the *Houston Chronicle*:

“Here we are, 14 months from (an election) and everyone is doing the classic thing we see here in Washington: It’s time to start either waiting people out until after the election or now is the time to strike and get something in place before change happens. That’s likely one of the reasons Serrano is OK with a 2028 moon mission,” Cowing said, especially since NASA programs backed by the current administration are typically gutted by the incoming president after the election.

But more than this, Serrano is a Democrat committed to President Donald Trump's impeachment. If he thinks impeachment could succeed, he will want to give the President nothing that could redound to his credit with the American people.

### NASA's Historic, All-Women Spacewalk

On October 18, NASA's Expedition 61 Flight Engineers Christina Koch and Jessica Meir of NASA concluded the world's first all-woman spacewalk. NASA [reports](#) that they completed a set of repairs with support from the International Space Station crew, including the European Space Agency Commander Luca Parmitano and NASA Engineer Andrew Morgan, and in Houston, Canadian Space Agency flight controller, Kristen Facciolo.

It was the first spacewalk for Meir and the fourth for Koch, who now has spent a total of 27 hours and 48 minutes spacewalking. It is the first spaceflight for both women, who were selected in the 2013 astronaut class that had equal numbers of women and men. Koch will remain in space for an extended duration mission of 11 months to provide researchers the opportunity to observe effects of long-duration spaceflight on a woman to prepare for human missions to the Moon and Mars.

Meir became the 15th woman to spacewalk, and the 14th U.S. woman. It was the 43rd spacewalk to include a woman. Women have been performing spacewalks since 1984, when Russian cosmonaut Svetlana Savitskaya spacewalked in July and NASA astronaut Kathryn Sullivan spacewalked in October. One of the next planned spacewalks will repair a cosmic particle detector. While most of NASA's accomplishments—so heralded during the JFK-led mission to land the first human being on the Moon—are now being ignored, if not attacked by the major media and much of the Democratic Party, this space walk made headlines.

President Trump, [spoke](#) to the two astronauts from the White House during their historic mission, marking the first time since 1969 that an American President has spoken to our astronauts while they were outside their spaceship. During the call, the astronauts praised all the



NASA

*Astronauts Jessica Meir (left) and Christina Koch prepare for their historic first all-female spacewalk outside the International Space Station on Friday, Oct. 18, 2019. Koch (above) working outside the ISS.*



NASA

female pioneers who came before them and made this incredible moment possible. "There has been a long line of female scientists, explorers, engineers, and astronauts, and we have followed in their footsteps to get us where we are today," Dr. Meir said.

We hope that we can provide an inspiration to everybody [who] has a big dream and that is willing to work hard to make that dream come true," she added. "Something that all of us that have made our way up here have done all throughout our lives. And I can tell you, the hard work certainly did pay off.

President Trump, after the conclusion of the discussion with the two astronauts, stated "This is a first step because we are going to the Moon and then we are launching to Mars. . . . First the moon, then we go to Mars." NASA Administrator Jim Bridenstine, seated next to the President during the call, further discussed the Moon-Mars mission, and that the Moon is a stepping stone to Mars with, first, the building of a "habitat . . . a space station in orbit around the moon" and then "a sustainable architecture at the Moon, we need to learn how to live and work on another world for long periods of time." We need that for Mars.

# Study Opens Way for Crash Program Joining Space Travel to Fusion Power

by Paul Gallagher

Oct. 19—The presentation which follows, “Mining Helium-3 on the Moon,” was given at the Schiller Institute’s October 5 conference, “Man as a Galactic Species,” in New York City, as part of more than 1,500 worldwide celebrations of “International Observe the Moon Night.” The speaker, Dr. Aaron Olson, has been working at the Fusion Technology Institute of the University of Wisconsin in a fusion research program with a unique focus. It includes one of the most scientifically inquisitive and distinguished astronauts of Project Apollo, the planetary geologist Dr. Harrison Schmitt. Now 84, Harrison Schmitt has only recently<sup>1</sup> written scientific papers about an idea he formed while walking on the Moon nearly half a century ago; but he has discussed the possibilities of the idea with Dr. Olson and other colleagues.

That moment of lunar insight in 1972 seems to lie at the origin of the realization of what is, today, the potential that a gas trapped in the surface soil of the Moon could power the production of electricity on the Earth for centuries.

Observing the remains of an ancient avalanche down a mountain on the Moon, Dr. Schmitt observed—as Dr. Olson explains in his talk—that something *like a fluid* had carried the avalanche along, far from the mountain. No liquid seemed present. He hypothesized an explanation: that volatile gases were trapped in significant quantities in the lunar surface (the Moon has no gaseous *atmosphere*), and that rapid movement or “agitation” of the soil released them. He did not then know what those gases could be.

Now, many years later, Dr. Aaron Olson has been continuing experiments at Wisconsin to test that phenomenon Harrison Schmitt guessed at, together with the application of heat, to release a gas which, today,

is known to be potentially the very best fuel for the long-sought process to produce commercial fusion power.

In fact, helium-3 could fuel the most energy-efficient form of limitless fusion power with no radioactive emission, versatile enough to propel rockets to Mars in a couple of weeks and to power civilization on Earth using the products of fusion reactions in the Sun, which the solar wind has deposited in large volume on and in the surface of the Moon—where it can be “mined.”

## A Crucial Experiment

Dr. Olson designed an experimental “miner” device to test the hypothesis and the potential to recover this fuel of potentially boundless benefit to mankind, helium-3, which scarcely exists on Earth.

It is a considerable challenge, given what Harrison Schmitt “discovered” (in his own mind) about the behavior of volatile gases on the Moon, without knowing then that one of them was helium-3. Inside the heating section of the experimental device, where the scientist wants to recover and collect the gas from the lunar soil, very fast motion and agitation of that soil is a benefit: Much more gas can potentially be released from the soil and collected. Outside that one section of the “miner,” which is equipped to capture the helium-3, in all the rest of the apparatus and processes being used, fast motion and agitation of the soil leads to a loss—what Dr. Schmitt has estimated may have been a 40-45% loss of the helium-3 from the lunar surface by agitation over many millennia.

To quote Aaron Olson in a recent discussion:

The result that came out of my thesis shows additionally, that increased *speed* also increases the amount of loss. So it would suggest to me, that if you can handle the material as slowly and carefully as possible, before it gets into the area

1. H.H. Schmitt et al., “Revisiting the Field Geology of Taurus-Littrow,” *Icarus* Vol. 298 (December 2017), pp. 2-33. Journal homepage: [www.elsevier.com/locate/icarus](http://www.elsevier.com/locate/icarus)

where you *want* the release to happen, an area where you have gas tanks and so forth attached to be able to do the collection, then *within* the area where you are doing the collection, you increase the speed and the interaction between the particles by making the path that the particles have to flow through the device as torturous as possible; or, in an area where, particularly, the sheer stress would be as high as possible. So the grains are rubbing against themselves and other grains at as high a speed as possible, therefore trying to release as much [gas] as possible by agitation.

This is years and many steps from the original discovery of a thought while walking the Moon's surface. Scientific progress often moves in this way: A scientist observes something anomalous, unexplained by what he or she knows of science and the environment. A thought-experiment produces an intuition as to what might explain it, which may develop over years as a result of observing what human effort discovers about that environment—such as the finding that helium-3 was present in lunar soil returned to Earth. Eventually experiments are designed which use what has become known, to test the hypothesis about what remains unknown—such as exactly what happens in the lunar soil when something sets it in motion.

Since that soil is constantly bombarded by the solar wind, cosmic radiation, meteorites, etc., and even moved by seismic activity, many such experiments have been devised, from afar and from lunar orbiters and landers, to solve those anomalies before human beings settle on the Moon and develop it. But *this* line of experimentation links that step of space exploration, to the power and propulsion source for many leaps to follow by “Mankind as a Galactic Species.”

### **The Cost of Not ‘Being Bold’**

But this crucial work at Wisconsin must be reported with the pangs of knowing that such experimentation could have been underway many years ago, and in many, many laboratories, had JFK's Apollo Project been continued, naturally expanded, and naturally become connected with a similar “crash program” for fusion. The Moon is a vital node in space for fusion power, which in turn is vital to travelling from the Moon into the Solar System.

As late as 1986—decades after the first lunar soil samples came back to Earth for testing, and nearly 15 years after Harrison Schmitt's on-site observations about volatile gases in the lunar soil—scientists working on fusion power did not know that there was plentiful helium-3 on the Moon; and NASA engineers and scientists, who did know that, did not realize that helium-3 had any importance for fusion research. There was an intolerable denial of the discovery interchange which crash scientific missions require, and which they also drive. The mutual ignorance only began to be broken when Harrison Schmitt, in 1986, joined Fusion Technology Institute and became a vital human link between two frontiers of science and human endeavor.

But that could not change a situation in which fusion researchers, although gradually learning of plentiful helium-3 on the lunar surface, did not believe NASA *was going to go back to the Moon at all*, let alone mine helium-3 there. And so, few worked on a fusion power reaction, which—however promising—used a fuel available in only vanishingly small, extraordinarily expensive quantities on Earth. And NASA people were not aware that helium-3 fusion experimentation was even competitive with tokamaks and laser fusion in national laboratories using deuterium and tritium.

Yet Aaron Olson says it could “lead to a real fusion power plant—in my opinion—well before the ITER or the NIF program,” referring to the International Tokamak Experimental Reactor project under construction in France and the National Ignition Facility, where laser fusion is being tested at Lawrence Livermore National Laboratory.

President Kennedy in 1962 spoke at Rice University of the many astonishing technology breakthroughs which had to be achieved in just a handful of years to get humans safely to the Moon and back—and they were achieved with amazing speed—and said, “We must be bold.” He added, “Cost is not a factor.”

If the Artemis program, today's new Moon-Mars mission, is funded at the levels really needed to meet its aims, it will become a “crash program” for space exploration that also relaunches advanced nuclear and fusion power development, now virtually abandoned. Let us proliferate such crucial experiments as the one described here.

# Mining Helium-3 on the Moon

by Aaron Olson

*This is an edited transcript of the speech presented by Dr. Aaron Olson to the Schiller Institute conference in New York, “Mankind as a Galactic Species: The Necessary Alternative to War,” on October 5, 2019. The full video of the conference of is available [here](#). Subheads have been added. For additional coverage of the conference, see EIR, Vol. 46, No. 40, Oct. 11, 2019.*

Good afternoon, everyone! It’s my pleasure to be here today with you all to celebrate the International Observe the Moon Day. My name is Aaron Olson; I graduated with my PhD from the University of Wisconsin, Madison, in 2018. My thesis topic was research to develop technology to harvest helium-3 from lunar soil.

I’ll start with why we’re interested in helium-3 in the first place. As others have brought up already during today’s conference, helium-3 could be a part of fusion fuel in reactors that could help us bring more energy across the world, and offer us opportunities to bring this sort of power production into space to help us with more exploration, to find out more of what’s going on in our own Solar System and potentially beyond, in the future.

**Figure 1** is a reactor at a facility for TriAlpha Energy [now TAE Technologies—ed.]. I like to show this image because it illustrates that technology around fusion isn’t just something on paper, or something that’s in the imagination of people across the world. There are companies right now who have been funded by billionaires and large



*An exhibit of Aaron Olson’s research for an efficient device for extracting helium-3 from the surface of the Moon, won First Prize in the “Group, Graduate” category at the University of Wisconsin-Madison’s Engineering Expo 2015. Olson (third from left) is seen here with one of his processing chambers and his collaborators in creating the exhibit (l. to r.), Alex Strange, Tashi Atruksang, and Abe Megahed.*

organizations that are developing this technology right now. This is one of the potential reactors that TriAlpha is working on. This particular device is capable of “burning” or fusing helium with deuterium to produce fusion power. It does it at scales that aren’t relevant for power plants today, but it’s the sort of technology that 10-15 years from now could allow us to have reactors.

So, when helium-3 is fused with deuterium, or when helium-3 is fused with helium-3, you get reactions that

FIGURE 1  
**<sup>3</sup>He Could Be a Significant Future Fusion Fuel**

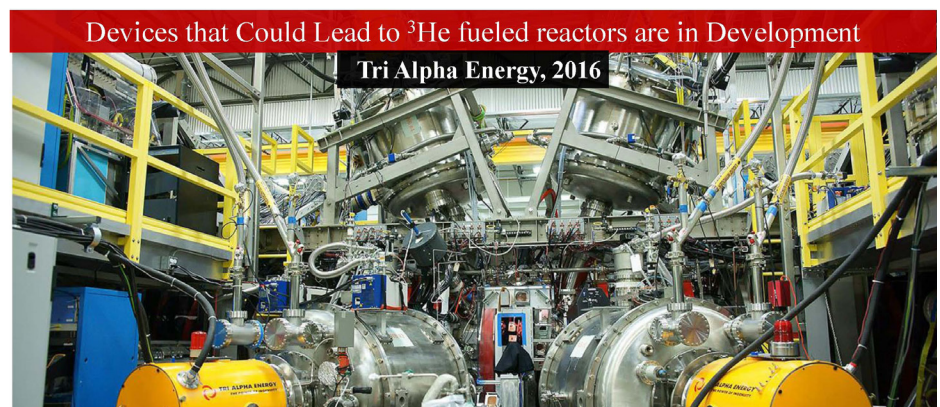
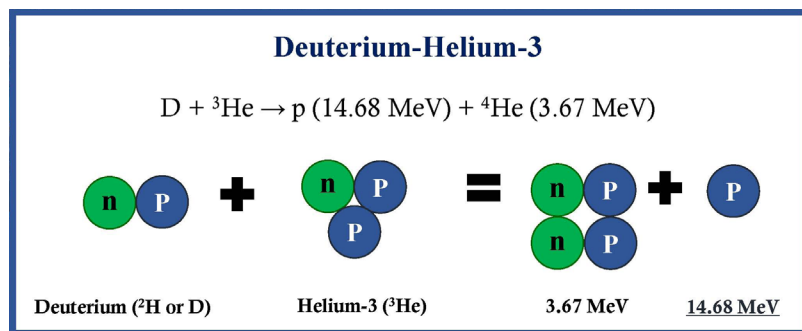



FIGURE 2



produce high-energy protons (Figure 2). As opposed to deuterium that’s fused with tritium, as what the ITER [International Thermonuclear Experimental Reactor] project is proposing, and many other more traditional approaches for fusion have proposed, this high-energy proton release or reaction product allows for the energy to be directly converted into electricity, instead of into heat, which then could be used in a Rankine cycle or any other thermal cycle to produce power.

This means that not only is this a more efficient way of producing power for power plants across the world. On top of that, with the reduction of the neutrons that would be produced in a deuterium-tritium power plant, or the neutrons that are produced in fission power plants today, you have a reactor vessel that doesn’t become radioactive. So, you get nuclear power without any radioactive waste. That’s incredible!

### Some Basics of Helium-3

Back to some of the basics around helium-3. Many of you may be wondering where helium-3 originates. It’s actually created in the Sun. At all times, the Sun is fusing hydrogen with hydrogen inside of its core; but it’s also fusing other things all the time. That’s how we get a lot of our heavier isotopes and heavier elements. They’re actually created inside of stars. So, helium-3, like many other things, is also created inside of a star.

What happens is, it’s emitted from the Sun in something called the solar wind. The solar wind is a flux of charged particles emitting from the Sun at all times. Because it’s charged, any body in the Solar System that has a magnetic field around it, deflects this charged flux of particles. Around the Earth, we have a

very powerful magnetic field that protects us from a lot of the things that are being emitted not only from our Sun, but from a number of other sources across the Solar System and our galaxy. A number of other bodies across the Solar System also have magnetic fields. On top of that, many bodies have forms of atmosphere. Fortunately for us, we have a very healthy atmosphere that protects us and allows us to live on Earth. All of that blocks out this flux of helium-3 and other charged particles that

come from the Sun.

But the Moon has neither a magnetic field nor a substantial atmosphere. So because of that, over the lifetime—4.5 to 5 billion years roughly, the time that the Moon has existed—a tremendous amount of helium-3 has been bombarded onto its surface (see Figure 3). A fraction of that still remains today, and is retained in the first 3-5 meters of depth of the lunar surface. Because of the Soviet missions in the 1960s and 1970s, and the Apollo missions in the 1960s and 1970s, we got proof of this. In fact, 360 kilograms of material from the Apollo missions was brought back to Earth. Samples from all of that material that came back were heated up, and in the process of being heated up, gave out not only helium-3, but a number of other volatile gases; proving that helium-3 was one of the elements and isotopes that was within that soil.

One place to get a lot of background on all of this, not only the solar wind part, but also the background on the Apollo samples—the Luna 16, Luna 20, and Luna 24 missions as well that brought back samples that had helium-3—is the book, *Return to the Moon*, by Apollo astronaut Dr. Harrison Schmitt. This came out in 2006,

FIGURE 3

### The Moon Could Enable over 1000 Years of <sup>3</sup>He Energy



FIGURE 4

### Lunar <sup>3</sup>He Miner Designs Have been Based on Recuperative Heating

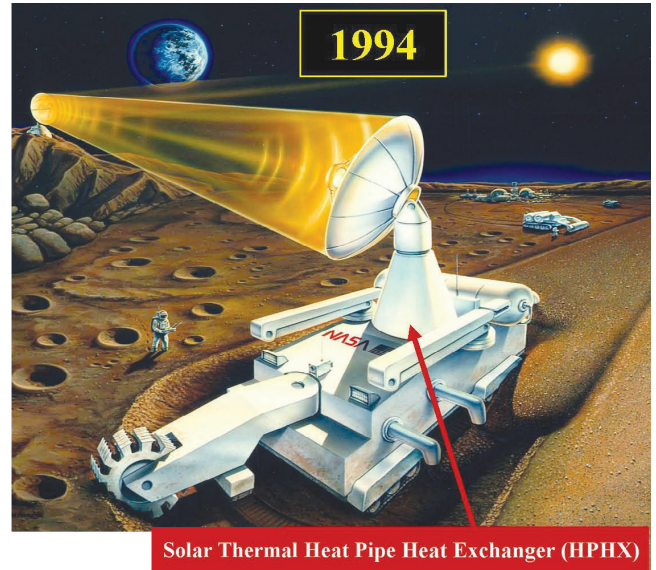
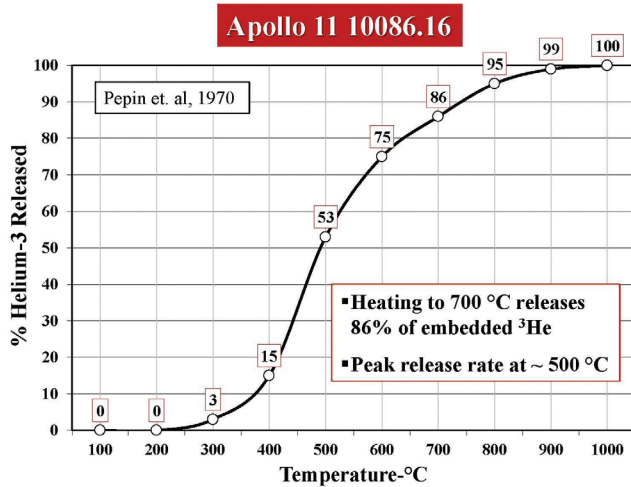

Mark II Helium Mining Robot

and it really summarizes a lot of the research that had been done in the 1980s, 1990s, and even into the 2000s around this topic.

### Mining Helium-3 on the Moon

As I mentioned, helium-3 can be brought out of the lunar soil by heating. We found out by tests at the University of Minnesota and the Johnson Space Center, that when lunar soil, or lunar regolith, if you will—the dis-aggregate that is covering most of the surface—when it’s heated up to 700 degrees Celsius, about 85% of the embedded helium-3 is released.

Based on that fact, a number of different robotic mining system designs were developed that can be used to extract helium-3 from the lunar surface. It started in the late 1980s. One of designs—the Mark II—is shown in Figure 4. The artwork is by John Andrews, and the lead mechanical engineer at the time who developed this was Igor Sviatoslavsky.

The key part of this design, the part that actually takes the soil and allows for the helium-3 to be extracted, is a heat exchanger. The heat exchanger takes energy through a bank of heat pipes from a solar ther-

### It Is Believed that Agitation of Regolith Also Releases <sup>3</sup>He

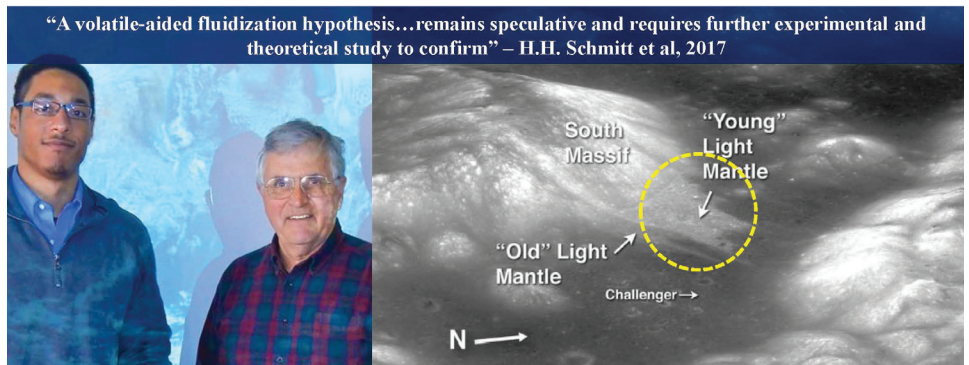

Aaron Olson (left) and Harrison Schmitt (right), 2013.

NASA LROC Image; Schmitt et al., 2017

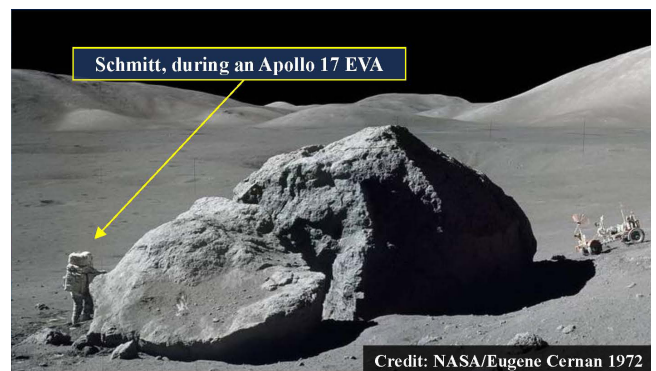

“Losses of helium-3 from Apollo 11 fines due to agitation may be at least 42% of the concentration in undisturbed regolith” —H.H. Schmitt, Return to the Moon, p.92.

## Approach Consists of Three Experimental Steps

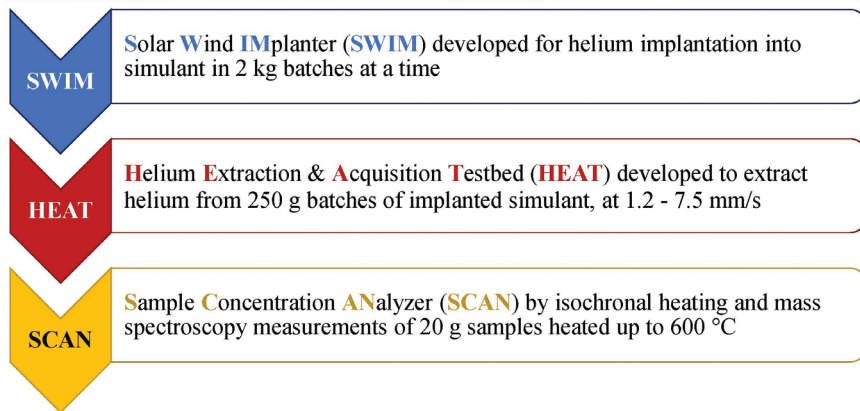

mal collector. Those heat pipes are what the regolith flows around as it passes through the device, heating it up and therefore allowing the gas to be released.

From his experience on the surface of the Moon, Dr. Harrison Schmitt thought that there might be another way that this gas could be released. By looking at the samples that came back from other Apollo missions and also from his own mission, Apollo 17, in 1972, he thought that agitation may also be a mechanism to release not only helium-3, but any volatile gases to be released from lunar soil.

Dr. Schmitt thought this because when he was on the Moon, he saw the trace of an avalanche, an ancient avalanche on the Moon, a flow that had travelled too far from the base of where the material started from. He thought that it must have been levitated or lubricated in some way to flow even further away from the initial mountain, if you will, on the Moon. So, he said, what could do that? There's no water, there's no liquid water on the surface of the Moon. What else could have made this material move so much farther? He thought maybe it was the gases that were released from the soil itself as it started to roll away from the base of the mountain. He said that therefore, the concentrations of helium and other gases that were coming off of the lunar samples had probably lost quite a bit not only from its handling on the Moon, but also in its handling back on Earth as it was being used for experimentation and so forth.

In his book, Dr. Schmitt said he believes that at least 42% of

the concentration of volatile gases was removed from a lot of the samples that came back to Earth, which could be substantial. Meaning that if that much is coming off of these samples, maybe you don't need heating at all, as in some of the other robotic designs we've had before. Or maybe some combination of heating and agitation might be the right approach.

## Two Approaches: Heating and Agitation

My research had two primary questions. Basically we wanted to create technology in the lab that would allow us to see how much we could get out by heating and how much could we get out by agitation; and how does the flow-rate of material through our device influence the amount that we're able to extract? I developed three sets of experiments to be able to do this.

The idea was, first we needed a batch of lunar regolith simulant that had a known quantity of helium already in it. We wanted to use helium-3 for our experiments, but helium-3 costs about \$30 million per kilogram on Earth right now. As you may or may not know, most of the helium-3 that we have access to for research across the Earth comes from the degradation of tritium that's in the [nuclear] warheads. So, the United States has quite a bit of it, and Russia also has quite a bit of it. And researchers around the world, when they want helium-3, that's where they buy the material. We weren't a super-wealthy institute at the University of Wisconsin, though we do have some good resources, so as a surrogate for helium-3 we used helium-4; which

## Research Objectives

### Primary Question:

What percentage of solar wind implanted helium is lost due to flow-induced agitation through the tube array of a HPHX?

If so, does the helium loss increase with regolith flow velocity?

### Secondary Questions:

- Can a high throughput ion implantation system be designed and operated to create helium-implanted batches of lunar regolith simulant?
- Can the controllable flow of simulant through a heat pipe heat exchanger be demonstrated?

## The Solar Wind Implanter (SWIM) Concept

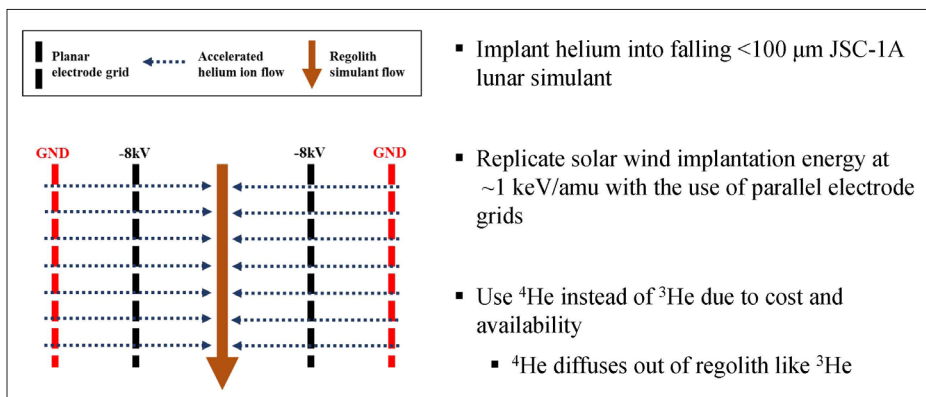
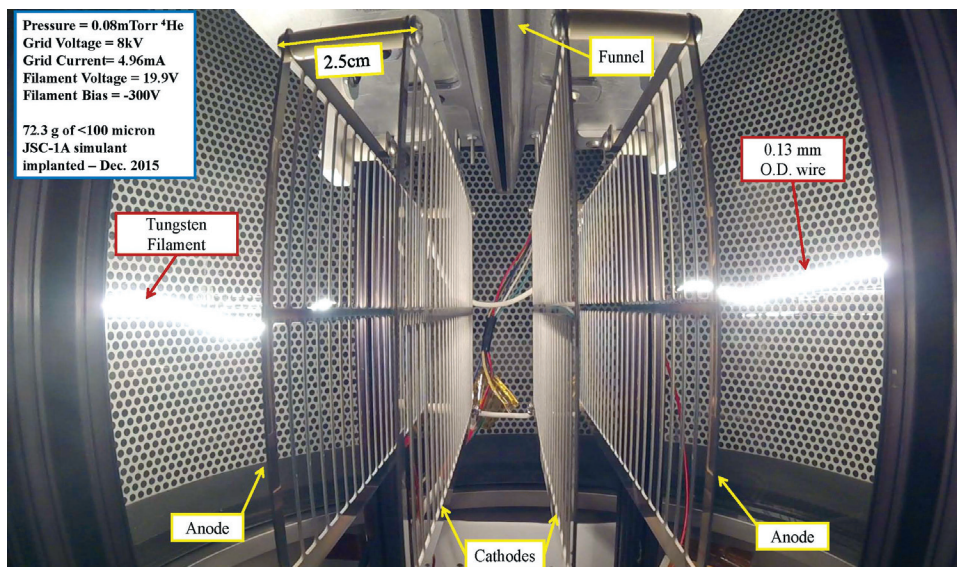

FIGURE 5



diffuses out of lunar soil very similarly, so for our cases it was basically the same.

We developed a device to implant helium into the lunar soil. We then developed a device to be able to process that implanted lunar soil in a form of a heat-pipe heat exchanger. It could raise the temperature of the regolith, and the additional elements of the heat exchanger allowed us to recoup some of that thermal energy so we wouldn't have to use so much of it to be able to raise the temperature of the regolith. Then lastly, we had a device in which we would heat up small samples of the material after it flowed through the heat exchanger, to be able to see how much remaining helium was there, therefore testing the efficiency of the device.

## Implanting Helium into Regolith

The concept around the implantation device was one that was fairly simple. We used pairs of electrodes where the cathodes would be held at a large negative voltage, and the outside grids would be held at ground. For those of you who know a little bit about electrostatics, basically that means that anything that's positively charged that's near the outside of those grounded anodes would be accelerated directly inward toward a falling stream of material. So we had a feeder device that would drop a thin stream of regolith downward, and then those two outside grids would accelerate the helium to smack into those particles and be embedded. In **Figure 5** you can see the device inside a vacuum chamber.

These outside grids here are the anodes—the cathodes obviously are in the inside, between them there—we used filaments to create some of the background ionization. We had this vacuum chamber and we filled it up with helium-4. We needed to create some positively-charged helium ions to start with, so the tungsten filaments, the same filaments that are in traditional incandescent bulbs, when they're heated up, they kick out electrons. And when those electrons smack into neutral atoms, they create positively-charged ions. So, we had this soup, if you will, of this positively-charged helium-4, and as soon as it got close enough to these grids, it got accelerated to the point that it would then embed itself in the falling material that was between the two grids.

The feeder equipment is shown in **Figure 6**. Everything that we used from the top part of this, except for

FIGURE 6

**SWIM Design: Principal Components**

**Power supplies**

- -20 kV, 15 mA high voltage
- -500 V, 5 A filament bias
- 30 V, 5 A filament heating

56 cm

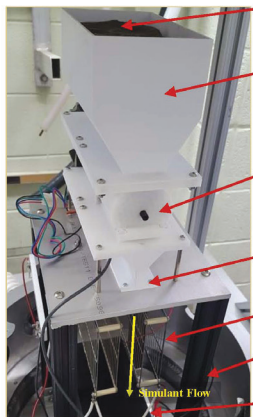
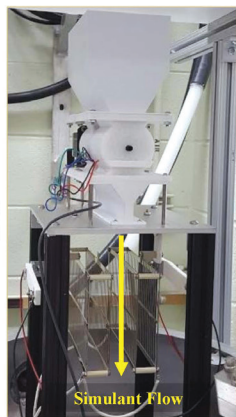

- Simulant (2 kg)
- 3D printed hopper
- 3D printed rotary valve feeder
- 3D printed funnel
- Set of grids
- 80/20 Aluminum structure
- 3D printed collection bin

FIGURE 7

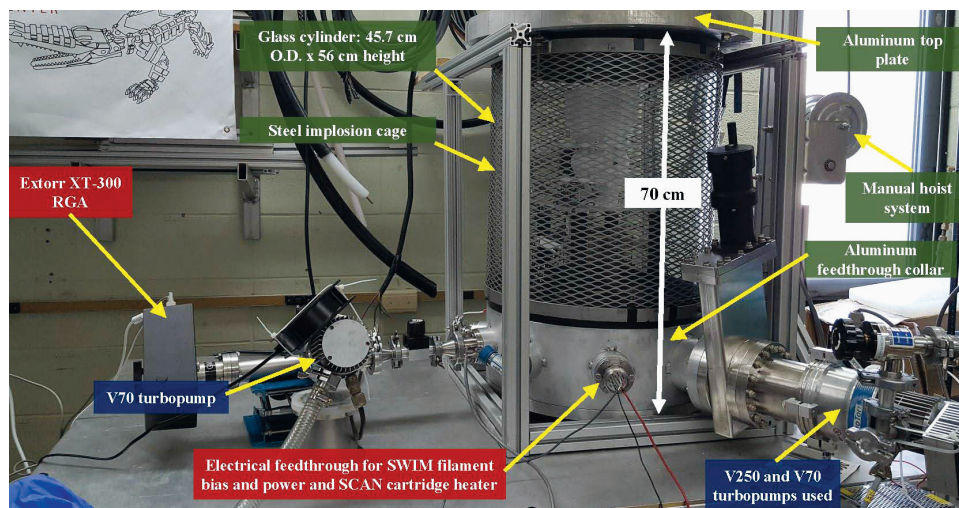

*A vacuum chamber system was assembled specifically for the SWIM system.*

FIGURE 8

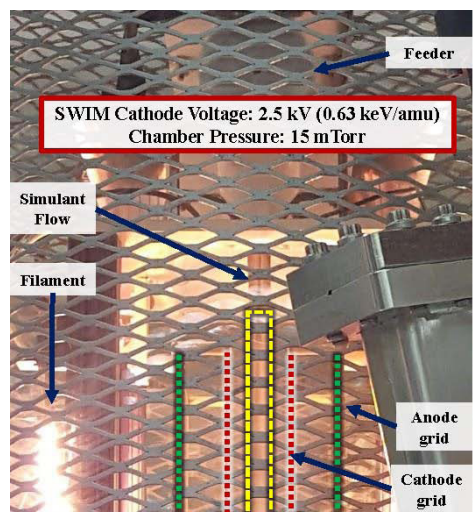
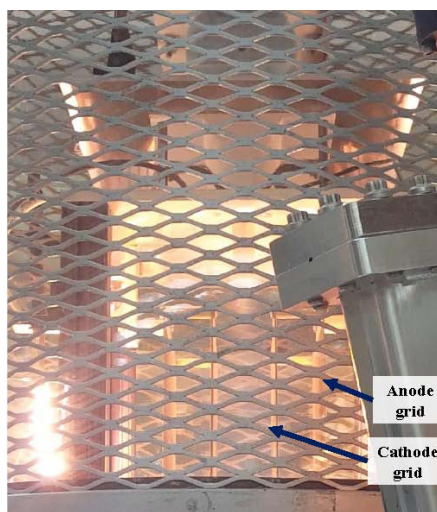

FIGURE 9



the motors and grids and so forth, was 3D printed. So, that made it a lot easier for us to be able to build something for this under a tight budget.

**Processing Regolith**

We learned a lot about how to process regolith. Regolith is a very nasty substance to work with. The reason is that, not only the real lunar regolith, but also the simulated lunar regolith that we work with here on Earth, is very jagged; so it sticks on everything. It's very fine-grained, so you have to wear masks when you're working around it, and whenever you touch it, it ends up sticking on your gloves and whatever equipment you're using. The feeder devices that we had to develop to be able to process it went through a lot of iterations before we got to something that actually worked reliably.

The vacuum system that we used to do this research in shown in **Figure 7**. In the back left corner of this image, you see a part of a flag from NASA Swamp Works. I'd like to give a shout-out to their group. They provided a lot of design assistance and a lot of advising along the way throughout this project as a part of the Space Technology Fellowship Program. In particular, Dr. James Mantovani and all of the great engineers down there at NASA Kennedy Swamp Works.

**Figure 8** shows you the system in use. See the grate in front of the image? That's the protective implosion cage around the vacuum chamber. **Figure 9** shows you the falling

FIGURE 10  
**Helium Extraction & Acquisition Testbed (HEAT) Concept**

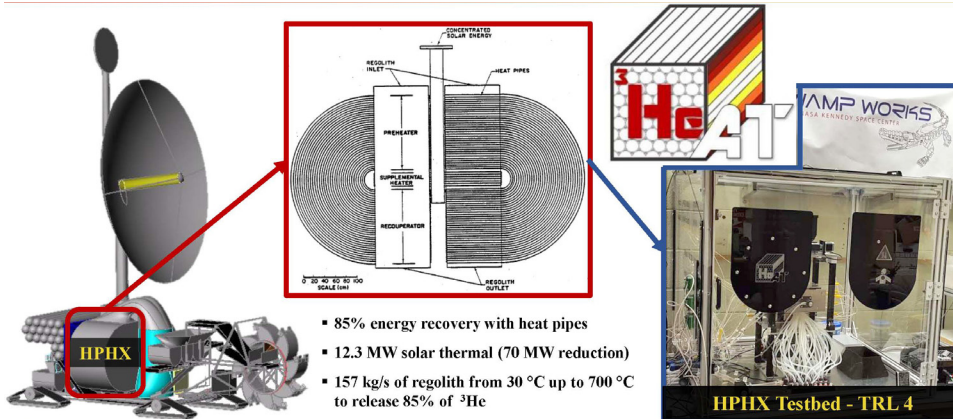

**HEAT Was Designed to Test Agitation and Thermal Extraction**

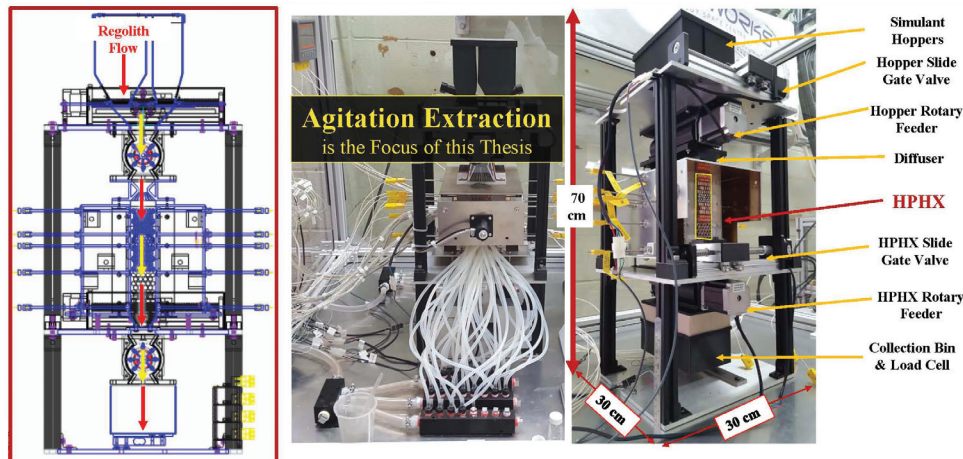
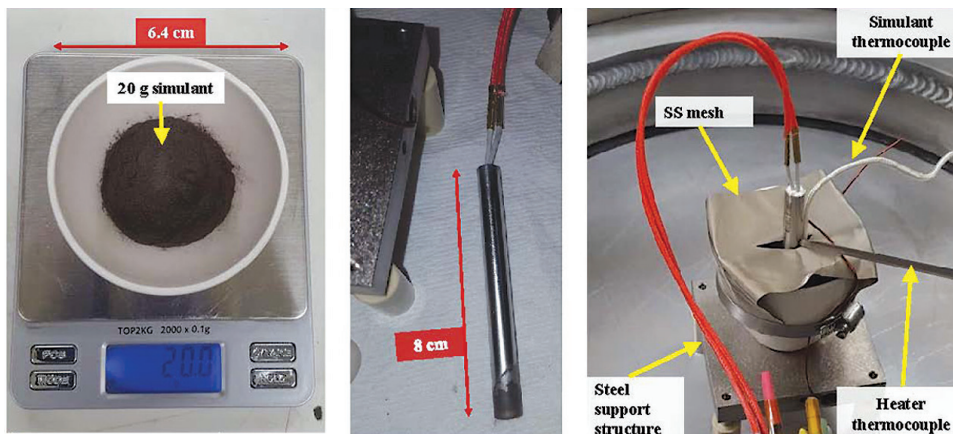

FIGURE 11  
**Sample Concentration Analyzer (SCAN) Components**



stream of regolith, which is highlighted here. You might be able to pick up a slight faint purplish glow inside of the vacuum chamber. That is the emission of light that occurs when you have these charged particles that are accelerated.

Now to the other portion of what we called the Helium Extraction Test Bed, namely the extraction or heat exchanger portion of the research. In large-scale devices, massive systems were designed, about three meters tall and about five meters in width—a gigantic device was conceptualized for this. But we needed to do something that would work in our lab in the university, so we built something that was about three feet by three feet. The glove box that it operated in can be seen in **Figure 10**, in the corner.

Similarly to the implantation device, there was a series of mechanical devices to feed regolith through the device, and on top of that there were heat pipes that were nestled in the key part of this where you see HPHX in the image on the far right. Additionally, there were a number of different spots for instrumentation where we would record temperatures, and we also passed coolant through the device in certain pieces to make sure none of the hot elements would melt any of the 3D plastic pieces.

FIGURE 12

### SCAN Vacuum System Setup

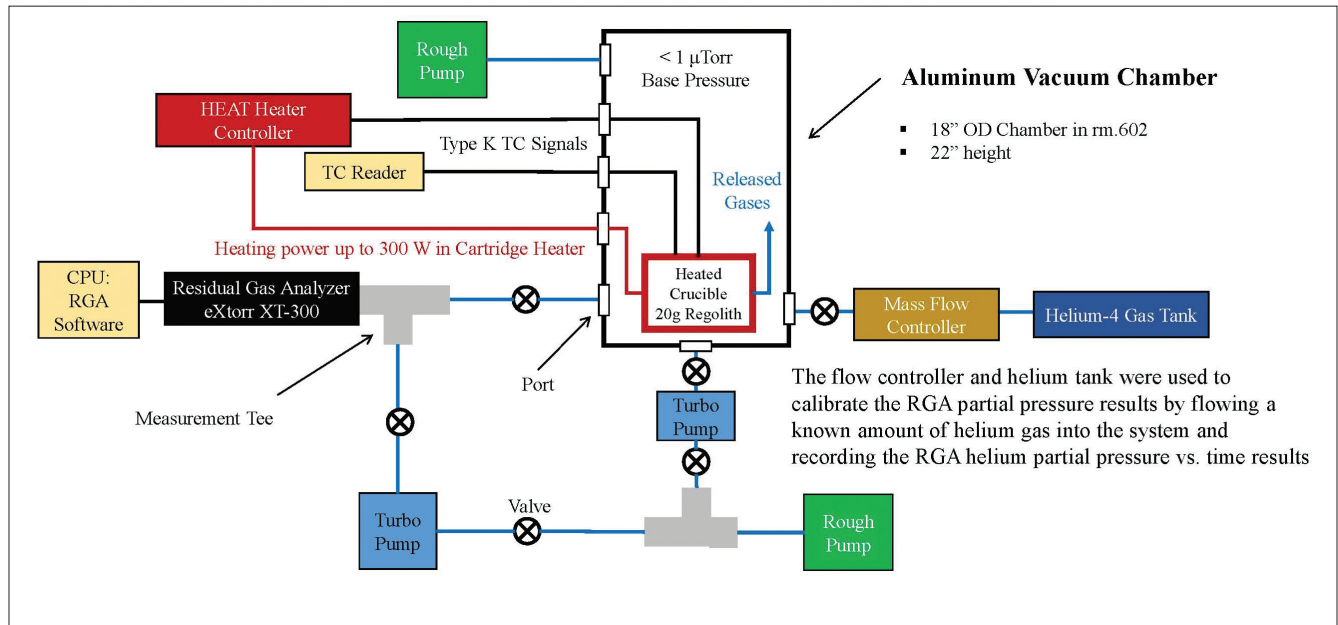

### Analyzing Results of Regolith Processing

Lastly, let's look at the SCAN, or sample concentration analyzer components shown in **Figure 11**. After passing a number of different series of samples through the heat exchanger, we then had to test how much helium was remaining. This is the process we ended up using, where we used a crucible. We would test about 20 grams of processed simulant at a time. We did the heating by using a cartridge heater. You might be aware of cartridge heaters for different applications in industry, but effectively it's a rod that gets extremely hot. We used ours to get to about 600-650 degrees Celsius. Then we would record the gases that were coming off of the 20 grams of simulant using a residual gas analyzer inside of a vacuum system. Here's a schematic of that vacuum equipment in **Figure 12**. In **Figure 13**, you can see an image of one of the cartridge heaters glowing hot during one of the tests.

FIGURE 13

### SCAN Procedure

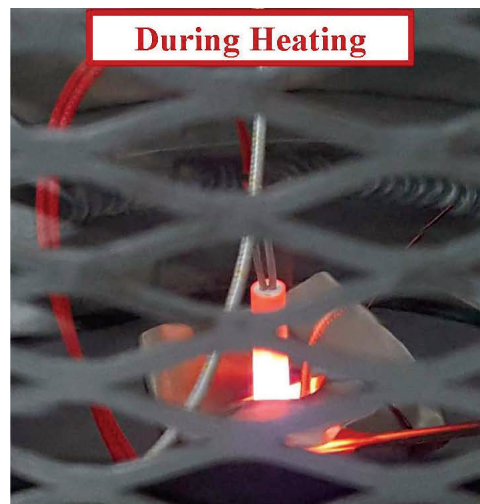

### What We Learned

What we learned from all of this experimentation is that the simulated regolith with helium that we produced released helium in a very similar way to real lunar samples. In fact, the graph in **Figure 14** shows you a comparison of the way that helium is released as a function of temperature for real lunar samples, with other analog samples that were developed at my university back in the 1990s, and with the JSC1A simulant that I used after implantation. So, you can see the evolution curve is very similar. This gives us confidence that the work

we were doing has application on a real lunar soil as well.

**Figure 15** shows probably the most important conclusion of the research we accomplished. As Dr. Harrison Schmitt thought back in the 1970s, after his mission to the Moon, agitation does play a big part. There are some questions as to how deep the implantation was with our particular work, exactly how much agitation

FIGURE 14

**Helium Release from SWIM Implanted Simulant is Similar to Lunar Regolith**

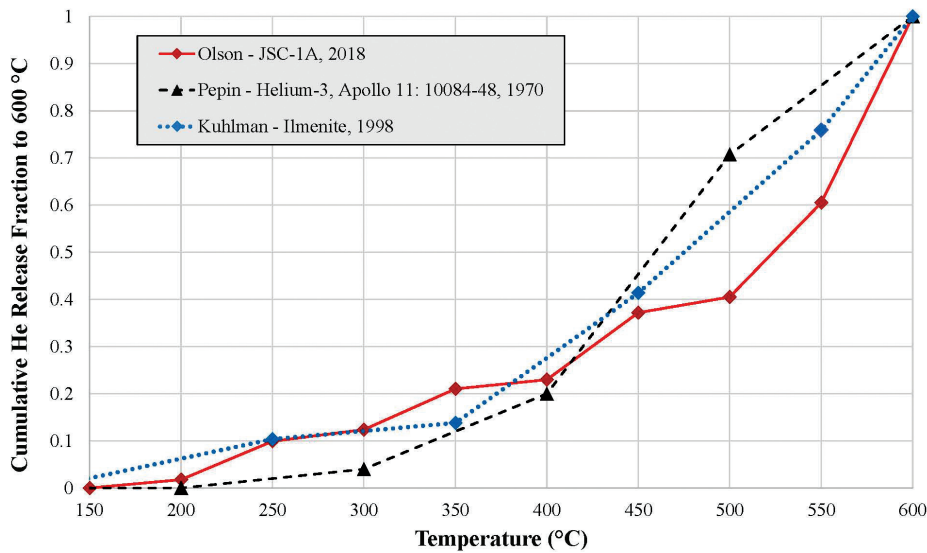

was happening with our equipment, and so forth, which is too detailed for this presentation.

But the most important result of our work, was that we recorded substantial amounts of helium being removed from our samples strictly by agitation. The agitation in our case was the movement of the material through the device. You can see in Figure 16, in the case of material flowing at 1.5 grams per second, the remaining concentration was a little bit less than 30%. That means that 70% of the helium that was implanted disappeared simply by the grains rubbing up against themselves

FIGURE 15

**Flow Induced Agitation Reduces Retained Helium in Simulant**

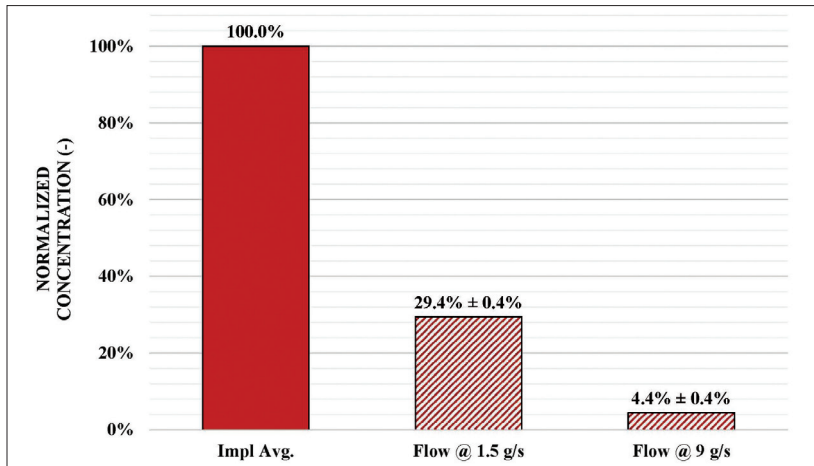

and other pieces of the equipment as it flowed through the device. At faster speeds, more than 95% of the implanted helium disappeared.

So what does that tell us? It tells us that future mining system designs, to be able to collect not only helium-3 but other volatile gases from the lunar soil, should definitely incorporate agitation mechanisms, potentially in place of, or at least in combination with heating mechanisms.

Again, I'd like to give a big shout-out to NASA's Space Technology Fellowship program, all of the engineers and support staff over at Kennedy Space Center and at

**Agitation Substantially Impacts Helium Release in Miner Systems**

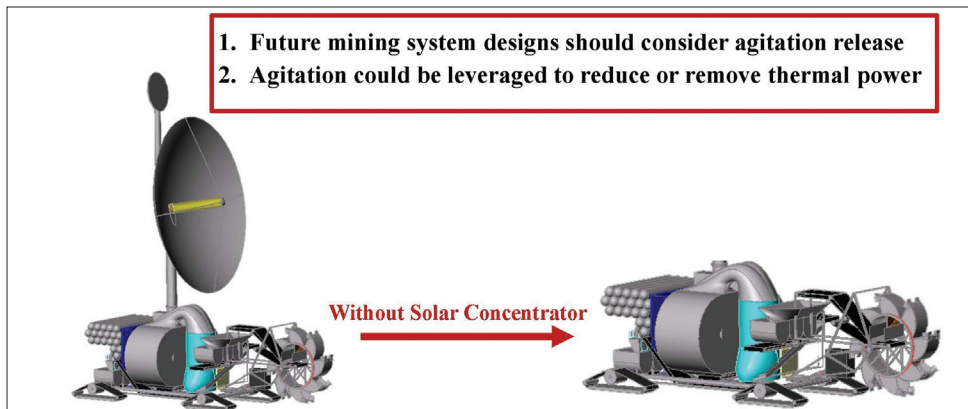

the University of Wisconsin, and in particular to Dr. James Mantovani for his mentoring throughout the process. And of course, my own advisor, Dr. Gerald Kulcinski, the leader of the Fusion Technology Institute. And lastly, Dr. Harrison Schmitt, for his motivation in the project, and for actually being on the Moon to observe some of this way back in 1972.



# More Scientists Reject Climate Hysteria as Bank of England Screams Bloody Murder

Oct. 21—An [international group](#) of now 700 prominent climate scientists and professionals will now function as a “network of experts” committed to “the mission to tell the complete climate story and to propose climate policies that respect scientific and economic realities.”

Professor Guus Berkhout, the co-founder of the Dutch Climate Intelligence Foundation (CLINTEL) and initiator and coordinator of a September 23 letter to the United Nations titled, “There is No Climate Emergency,” released the statement of mission and the expanded list of signers on October 18 at the Natural Variability and Tolerance Conference in Oslo, Norway, once again underscoring that it is important to warn political leaders that “the general-circulation models of climate on which international policy is at present founded are unfit for their purpose and that the models, which have predicted far more warming than they should, are not remotely plausible as policy tools.” These models, he said, “exaggerate the effect of greenhouse gases such as CO<sub>2</sub> and ignore the fact that enriching the atmosphere with CO<sub>2</sub> is beneficial.”

## Carney Goes to the Brink

Mark Carney, the Governor of the Bank of England, testified to the House of Commons Oct. 15, pushing climate computer models so fantastic that they can directly convert economic investment into Centigrade



CC/Bank of England  
*Mark Carney, Governor of the Bank of England, in 2013.*

temperature readings! The report of this testimony in the British newspaper *The Guardian* does not make clear where Carney got the model or models, but it is evident that they put Prof. Michael Mann’s notorious “hockey stick curve” completely in the shade.

Carney is reported to have started by explaining “that the global financial system is backing carbon-producing projects that will raise the temperature of the planet by over 4°C.” He “said the multitrillion-dollar international capital mar-

kets—where companies raise funds by selling shares and bonds to investors—are financing activities that would lift global temperatures to more than 4°C above pre-industrial levels.” Associated global sea level rise: ca. 40 feet.

The newspaper continues, “Carney told the committee that the GPIF [Japan’s Global Pension Investment Fund] analysis showed it held assets consistent with 3.7°C heating, and that the fund was now trying to manage this down. He said that AXA, the French insurance group, priced U.S. government bonds at 5.4°C, to reflect the carbon-intensive nature of the American economy. The U.K. is much lower, he said.” This gives us an idea of just how wonderfully powerful the “green finance taxonomy” of companies, compiled and applied to them by Wall Street financiers, must be.

All this the newspaper described as a “stark warning,” although “stark naked warning” might be more

apt. It has still not been established by any public pronouncement, that Mr. Carney personally knows anything about climate science or Earth's temperature record. The total rise in temperature since the oft-cited 1880 "start" of the industrial age is 0.4°C in 140 years. Computer models claiming escalating temperature rise after 1990 have consistently proven wrong. Carney's new model may be postulating nuclear war, to get all that heating—but after a short while, that's supposed to lead to planetary nuclear winter.

### The London Kill List

On January 7, 2015, the results of a climate-hysteria study produced by University College London (UCL), were published in *Nature* magazine, pushing the Malthusian calculus to its limits. *The Guardian* reported on it in an [article](#), "Leave fossil fuels buried to prevent climate change, study urges," the same day. The article trumpets that the suicide pledges signed by nations to "combat climate change," mean bleak prospects for coal. Internationally, "82% of today's reserves must be left underground. In major coal producing nations like the U.S., Australia and Russia, more than 90% of coal reserves are unused in meeting the 2°C pledge [to keep temperature rise under 2 degrees Centigrade]. In China and India, both heavy and growing coal users, 66% of reserves are unburnable."

The UCL fake-science study was clearly released to push the Paris Accord agenda, and foreshadowed the Carney offensive now in full force. *The Guardian* noted that the study revealed "the profound geopolitical and economic implications of tackling global warming for both countries and major companies that are reliant on fossil fuel wealth." The newspaper, pushing the anti-industrial "eat the babies" agenda of the British Empire, reported that the UCL study demonstrated that—

trillions of dollars of known and extractable coal, oil and gas, including most Canadian tar sands, all Arctic oil and gas and much potential shale gas, cannot be exploited if the global temperature rise is to be kept under the 2°C safety limit agreed by the world's nations.



Chinese coal power plant.

CC

Carney is continuing to escalate the campaign for incentives capable of pushing investors to fully "divest" from any form of carbon-based economic activity. An Oct. 14 [article](#) in *The Guardian*, "Rise of renewables may see off oil firms decades earlier than they think," has to be seen in the context of that drive.

The British newspaper reports, "The world's rising reliance on fossil fuels may come to an end decades earlier than the most polluting companies predict, offering early signs of hope in the global battle to tackle the climate crisis. The climate green shoots have emerged amid a renewable energy revolution that promises an end to the rising demand for oil and coal in the 2020s, before the fossil fuels face a terminal decline." Readers should be reminded that keeping "global warming" below the 2° Centigrade mark was adopted as a common target at the 2009 Copenhagen summit in the aftermath of the financial crash.

In April 2015, Carney, heading the Financial Stability Board of the Bank for International Settlements (BIS), was mandated by the G20 to examine the "risks" of climate change for the global economy. In September 2015, [speaking](#) to a Lloyd's of London dinner, Carney warned that there may be trillions of dollars of "stranded assets," meaning that investments linked to the carbon-based economy could lose their value virtually overnight, provoking bankruptcies and forcing governments to inject taxpayer's money.

---

### III. Our Russian Partner

---

VALDAI DISCUSSION CLUB PLENARY

## Vladimir Putin: ‘Global Problems Cannot Be Resolved Without Asia’

*Oct. 19—The following is a slightly abridged version of the speech delivered by Russian President Vladimir Putin on Oct. 3, 2019, at the final plenary session of the 16th meeting of the Valdai International Discussion Club, in Sochi, Russia. The speech is followed by a few selected questions and answers. The session was attended by Ilham Aliyev, President of Azerbaijan; King Abdullah II, of Jordan; Kassym-Jomart Tokaev, President of Kazakhstan; Rodrigo Duterte, President of the Philippines; and many other international guests and dignitaries.*

*In this speech, President Putin has defined a necessary approach to international relations that should be heeded by all people of good will in the world. To put it in American terms, what Putin describes as the approach to be taken is a “Community of Principle among Perfectly Sovereign Nations.” This is a world without hegemonies, but also a world not simply reduced to individual competing interests; it is, rather, a new order of national sovereignty and cooperation beneficial to all.*

*As Putin emphasizes, it was the collaboration between Presidents Trump and Putin in Syria which was crucial to resolving that catastrophe. This demonstrates what is possible when nations work together. The new set of relations among nations that is emerging can potentially lead to an unprecedented era of peace and economic development.*

*Subheads have been added.*

Your Majesty King Abdullah, Mr. Aliyev, Mr. Tokaev, Mr. Duterte, friends, ladies and gentlemen. . . .

This time, the hosts have come up with a truly inexhaustible and, I would say, fascinating topic which is



*Russian President Vladimir Putin addresses the final plenary of the 12th Annual Meeting of the Valdai International Discussion Club in Sochi, Russia on October 22, 2015.*

[kremlin.ru](http://kremlin.ru)

“The East and the Role of Asia,” as the world’s largest and most populated region. Relations between Russia and the Asian states, which have always been of particular importance to us, I believe, are of interest to everyone. The nature of Russia’s relations with Asia is dictated not only by today’s realities, but by history as well.

India and China, Egypt and Iran, Turkey and Japan, the countries of Central and Southeast Asia are heirs to great ancient civilizations, which gave humankind unique knowledge and technology, as well as discoveries in medicine, mathematics, culture and the arts.

Asia has always aroused special feelings among intellectuals and creative people, it seemed a little mysterious and mystical, and was considered a source of spiritual strength and wisdom, perhaps not always fully understood, but invariably interesting.

In Russia, the bright colors of the East inspired many of our writers, poets, artists and musicians, spe-



kremlin.ru

*Vladimir Putin addresses the plenary of the 16th Annual Meeting of the Valdai International Discussion Club on October 3, 2019.*

cifically Pushkin, Rimsky-Korsakov, Arsenyev, Vereshchagin, Kandinsky and Roerich. The Russian people, and not only Russians, know these names.

Today, Asia, throughout its vast reach from the Maghreb and the Middle East all the way to East and Southeast Asia, is regaining its natural place in international affairs, which is commensurate with its great heritage and today's undoubtedly vast and growing potential.

The positions of the Asian states are becoming stronger in all areas, but mainly in the economy. The region already accounts for over a third of the gross world product. Living standards are improving at a higher pace than the global average. The most advanced technology is being introduced. The unprecedented scale of integration processes and globalization are drawing both individual countries and entire adjacent sub-regions to Asia.

While demonstrating impressive examples of progress, the Asian nations still preserve their unique features and traditions. They remember their roots and prove in their forward progress that the principles of state sovereignty do not contradict openness and globalization, that sustainable development can be based on independence

played an enormous role in the democratization of international ties. Today, it is obvious that global problems cannot be resolved without Asia. Of course, it is possible to try to do this with momentum and based on past experience, but the legitimacy, and most importantly, the practical value of such approaches, which are presented as global and universal, will be questionable.

The world has become multipolar and, hence more complicated largely owing to the Asian countries. But, as I have said, multipolarity as such is not a cure-all. Nor does it mean that urgent problems will disappear by themselves.

### **Time for Outside-the-Box Steps**

The authors of the annual Valdai Club report insist, and we have just heard this, that we have entered an era with no world order whatsoever. This has been practically voiced right now. Yes, such a scenario is indeed possible. But it is fraught with many threats; we are

all aware of that. I would like to hope that however complicated the relations between countries, however dangerous the legal lacunae might be, such as in nuclear and missile weapons areas, the world order, based on the key role of international law, will be transformed,



Portrait by Vasily Tropinin

*Alexander Pushkin*

but it will remain. We will all be working to protect it. A different way is obviously fraught with global calamities for practically all of humanity.

The world system is undoubtedly multi-faceted and complicated and unprecedentedly interconnected at that. Everyone has their own objective interests that do not always coincide with those of others; this is also evident. But there is a feeling of common responsibility. Ultimately, I hope, no, actually, I do not doubt that there is also common sense, a striving for security.

This is why we cannot do without a systemic world order. But we also need both flexibility and, let me add, non-linearity, which would not mean a rejection of the system but the capability to arrange a complex process rooted in realities, which presupposes the ability to consider various cultural and value systems, the need to act together, dismissing stereotypes and geopolitical clichés. This is the only way to effectively solve the challenges on the global, regional, and national levels.

We have such examples before our eyes. Those of you who attended the 2015 Valdai Club meeting may remember that at virtually the very same time the decision was taken on Russia's operation in Syria. Let me be straightforward: not everyone, including the experts in the audience back then, believed it could bring a positive result. On the contrary, they were very skeptical about it, and many of them asked questions about why it was necessary. They asked if we understood what sort of a hornets' nest we would get into, whereas some foreign partners, I do not mean those experts present here, I mean just foreign partners with whom we collaborate in the global arena, were also trying to interfere, to resist.

But I would like to draw your attention to the essence of what has been done, and above all, of course, I mean what has been done for our country, as I represent its interests. We defeated the terrorist international that was actually winning on Syrian territory, and we prevented the return, the infiltration of hundreds and later, perhaps, thousands of armed cut-throats into our country and neighboring countries with whom we have a visa-free regime, our borders are transparent.

Most of Syria was freed from terrorists within several years, and the level of violence has drastically decreased. In conjunction with our Astana format partners and with the support of the UN, we managed to launch an intra-Syrian political process and to establish close working contacts with Iran, Turkey, Israel, Saudi Arabia, Jordan and other countries of the Middle East,



White House

*President Donald Trump and North Korean leader Kim Jong Un shake hands across the Military Demarcation Line between the two Koreas on June 30, 2019.*

as well as the United States. Colleagues, you will agree that it was difficult to even imagine such a complicated diplomatic alignment with the participation of very different states with very different emotions towards each other even a few years ago. But now this is a fait accompli, and we managed to do it.

### **The Syrian Settlement as a Model**

We think the Syrian settlement can become a model for resolving regional crises where diplomatic mechanisms will be used in the vast majority of cases. The use of force is an extreme and forced exception. Indeed, in Syria, we were faced with an attempt to create a terrorist quasi-state with an actual—I am saying this without any exaggeration—an actual terrorist army.

Occasionally, many new and chronic problems and crises look too tangled and even approaching them is a problem. But, I repeat, now is the time for outside-the-box steps and actions. In Syria, Russia and its partners (of course, we could never have done this alone) managed to do a lot while adhering to and following norms of international law, respecting sovereignty and thinking primarily about the life, safety and interests of the people.

I am convinced that these approaches can be used to resolve other existing problems in the world, including in Asia, such as for example, the situation on the Korean Peninsula, which has long been in a clinch.

In this regard, notably, as soon as the United States

decided to have a direct conversation with the Democratic People's Republic of Korea, without preliminary formalities and conventions, abandoning the usual, sometimes very rude, even insulting, rhetoric, the hope for a peaceful settlement immediately appeared.

Of course, we understand and see that there are still many unresolved problems and a long way to go. But there is movement in the right direction. We must give credit to President Trump's courage and ability to take outside-the-box steps. Indeed, for many decades, U.S. presidents ignored the DPRK and saw it as an outcast. Mr. Trump was able to take a historic step, overcome the "demarcation line" of misunderstanding and alienation, meet with Kim Jong-un and begin the negotiating process.

Let me repeat: the most complicated conflicts, such as the Palestinian-Israeli and Afghani or the situation around the Iran nuclear deal, can and must be resolved on the principles of mutual cooperation, respect, recognition of all the parties' interests and rejection of any kind of blinkers or philosophy of blocs.

In this context, let me remind you that this was Russia's logic this July, when it presented the concept of providing collective security in the Persian Gulf area. I believe the idea is still important, considering the tense and unpredictable situation there.

We suggest that the accumulated prejudices and mutual pretenses must be pushed aside, and a security and cooperation organization be created in the region almost from scratch. In addition to Western countries, Russia, China, the U.S., the EU, India and other interested countries could join as observers.

### **A New Global Concert of Development**

Ladies and gentlemen, of course, economic cooperation, which opens real prospects for sustainable long-term development for everyone, is the basis of equal political relations aimed at the future, including between Asian countries.

Let me use transport interconnection as an example.



CC/Tuomas Romu

*The Russian nuclear-powered icebreaker Vaygach (left) escorting the bulk cargo carrier Pavel Vavilov from the port of Sabetta on the Yamal Peninsula on April 3, 2015.*

It is impossible to develop trade and industrial cooperation and establish mutual exchanges in any other sphere without an up-to-date road, sea and railway infrastructure. We should think together how to speed up the establishment of such a Eurasian transportation framework, a real network of latitudinal and longitudinal trading routes.

Of course, Russia is open to this joint work and is already implementing several joint projects, such as the North-South trading route from Europe via Russia to the Caspian Region, Central Asia, Iran and India. Another route, Europe-West China, will connect Russian Baltic ports with Yellow Sea ports.

There is one more prospective route, the Arctic-Siberia-Asia. The idea is to connect ports along the Northern Sea Route with ports of the Pacific and Indian oceans via roads in East Siberia and central Eurasia. In order to implement this and add the missing links, we intend to speed up the construction of railways around the port in Sabetta (it is located in the north of Russia, on the Yamal Peninsula), to accelerate and complete the construction of the entire Northern Latitudinal Railway project complex as well as the construction of the Kuragino-Kyzyl railway (Kyzyl is located in the Republic of Tyva in eastern Russia) to later connect it to the railway network of Mongolia, China and other countries in the region. We are ready to work with all interested parties on this initiative, which is significant for the whole of Eurasia.

It is obvious to us that diversity within a nation is normal. It teaches both patience and tolerance in the



CC/Pierre André Leclercq

*The Trans-Mongolian Railway negotiates a curve in the Gobi Desert, September 2011.*

true meaning of these words, and the ability to understand and accept different opinions, traditions and ways of life rather than impose our model as an axiom. We believe our experience can be useful for many of our partners.

With regard to the world in general, since all nations are obviously different, uniformity and universalization are impossible by default. A system is required whereby different values, ideas and traditions can co-exist, interact and mutually enrich one another while retaining and highlighting their peculiarities and differences. . . .

So, in the 19th century they used to refer to a “Concert of Powers.” The time has come to talk in terms of a global “concert” of development models, interests, cultures and traditions where the sound of each instrument is crucial, inextricable and valuable, and for the music to be played harmoniously

rather than performed with discordant notes, a cacophony. It is crucial to consider the opinions and interests of all the participants in international life. Let me reiterate. Truly mutually respectful, pragmatic and consequently solid relations can only be built between independent and sovereign states.

Russia is sincerely committed to this approach and pursues a positive agenda. We stand for strict compliance with international law and enhancing mutual confidence and respect. We are building interstate relations and communication on fair and democratic foundations with an emphasis on the UN Charter.

Our country is focused on stepping up security and stability, on fighting international terrorism and other threats and challenges. We act for the sake of establishing—including in Asia—a system of equal and indivisible security resting on far-ranging and collective work.

Incidentally, the Russia-Africa Summit will be held here, in Sochi, in three weeks. We are prepared to propose to our African colleagues and friends a broad agenda of equal interaction covering many different areas—the economy, energy, transport, education and the environment.

### Russia’s Resurrection

In conclusion, I would like to divert from the main topic and tell you something, which, just the same, is related to it. I would like to say that it was almost 20 years ago—just before the year 2000—that my article, “Russia at the Turn of the Millennium,” was published. The analysis of global affairs and development prospects it then offered seems to me to have generally matched reality.



EIRNS/Connor Soules

*Street vendors in St. Petersburg, Russia in November 1999.*

Indeed, in the 1990s, Russia lived through one of the hardest periods in its history. In addition to the deep political, economic and social crisis in the country, we found ourselves exposed to aggression by international terrorism. At the time, Russia drew close to a very dangerous line and if it had crossed it, it would have faced the worst thing for any nation and country, which is the break-up and disintegration of the state. The threat was in the air and the majority of people were aware of it.

Of course, back then we could—the threat was absolutely real—plunge into the abyss of a large-scale civil war and be stripped of national unity and sovereignty, ending up on the periphery of global politics. It was only thanks to patriotism, bravery, and the rare ability of the Russian and other peoples living in the country to bear the hardships and work hard so that Russia could move back from this dangerous line.

Of course, there are things that could have been done differently and better during these 20 years. But we have gained unique experience, and I believe there is demand for it around the world. Before we came into this room, my colleagues and I discussed one of the most important issues today—terrorism.

Indeed, we in Russia still have to address plenty of issues. At the same time, due to political stability and the efforts of the whole nation, Russia has not only recovered and continues to grow stronger economically and socially, it confidently ranks among the leading, authoritative and responsible countries. Our country complies in full with its obligations as one of the guardians of the existing world order. I am sure this will continue in the future. This will be even more effective if we work together.

Thank you very much for your attention.

\* \* \* \*

*President Putin's speech was followed by a lengthy discussion period. We present here a few selected questions and answers.*

**Mikhail Pogrebinsky:** I am from Ukraine, and our country is going through troubled times. I have a question for President Putin.

This year was marked by a big electoral cycle, we have had a “reset” of both legislative and executive powers. The elections and polls reveal that public opin-



The Presidential Admin. of Ukraine/Mykola Lazarenko

*Volodymyr Zelensky walking to the presidential office in Kiev, following his inauguration as President of Ukraine on May 20, 2019.*

ion favors stability and a peaceful settlement in the east of the country.

The new authorities are trying to take the first steps, somewhat cautiously, towards a search for peace. But they are so timid that they raise doubts about their resolve and ability to arrive at the logical completion of the process.

Do you see any political forces in Ukraine—perhaps you can name them—that can act as drivers of this process of political settlement?

**Vladimir Putin:** . . . [R]egarding the new leader's efforts for a settlement in the southeast of the country. I do not know how strong are those who are against a settlement, especially based on the Minsk agreements. Thus the public's interest in a settlement is obvious.

I think Mr. Zelensky won the [Presidential] election so convincingly primarily because of that interest. People in Ukraine are waiting for this issue to be resolved. And if he has enough political courage and strength to complete it, I think he will assert himself as an honest politician, brave and capable of pursuing the decisions made.



I think he is sincerely willing to do that, it is his sincere conviction, at least his striving. It is hard for me to say if he is able to stand up to those who oppose the process, but we do see some hesitation.

It seems inevitable that he will need to look for compromise, come to terms with the whole nation, with all members of society regardless of their point of view. However, he still has to follow up on election promises he gave to the majority of the Ukrainian people.

**Tatiana Kastoueva-Jean:** Good afternoon, my name is Tatiana Kastoueva-Jean. I am an analyst at the French Institute of International Relations in Paris.

Mr. President, I have a question for you. At the beginning of your speech, you proposed outlining the shape of the future and talking about it. One serious subject, of course, is global warming, climate change. . . .

As for Russia, it seems to me that there has always been such a duality in relations, even in the doctrines, because Russian Environmental Security Doctrine says the right things, while the Economic Security Doctrine through 2025 says that green economic development is a threat and has risks for the Russian economy, and it is clear why: because oil and gas represent a very high percent of exports.

It's the same thing, the same duality in the reasons for explaining climate change. Is it the result of human activity, or is it part of the Earth's global cycles?

. . . Do you think that Russia put an end to these doubts, hesitations and questions by ratifying this agreement? Will a new socioeconomic development paradigm emerge now at the domestic and external global levels? Will this topic be a unifying measure, or the cause of further division?

**Vladimir Putin:** As for the uniformity of approaches and evaluations, we will probably never reach this. Indeed, experts in various fields who somehow try to answer the question about the causes of climate change do not give unambiguous answers to the causes of climate change.

There are different opinions, I have heard them. Some say there is some global change in space that



kremlin.ru

*Vladimir Putin at the plenary session of the 16th Meeting of the Valdai International Discussion Club on October 3, 2019.*

affects the Earth, so from time to time huge changes like this take place on our planet. I sailed along the Lena River in our country and saw high banks with deposits containing the remains of obviously ancient tropical mammals, which lived in tropical seas. I am talking about the Lena River, its stretch north of the Arctic Circle. It means back then the climate there was like this. Well, were there any anthropogenic emissions at the time? Of course, not. You see, there is no answer.

Just the same, my position is that if the human race is responsible for climate change, even in the slightest degree, and this climate change has grave implications, and if we can do something to, at least, slow down this process and avoid its negative consequences, we must spare no effort. This is our position. Despite all disagreements, we will support the international efforts to combat climate change. . . .

**Fyodor Lukyanov:** Angela Stent and Jill Dougherty [British-born director of Georgetown University's Center for Eurasian, Russian, and East European Studies, and CNN's Moscow Bureau Chief, respectively—ed.] would like to ask the President about this, and actually this question can be addressed to all participants as well. The situation in the United States is rather complicated at the moment and has become particularly so in the past week.

It is hard to understand what is happening there,

with domestic policy issues clearly dominating. Is it possible to build relations in such condition at all? Or maybe we should wait?

**Vladimir Putin:** As regards the developments in the United States—how can we cooperate with them when they are so engaged in their domestic political affairs? Obviously, this is always the case during an election campaign, and the United States is no exception. But this domestic political race has got a little over the top. I do not think this has ever occurred in the history of the United States before.

But life goes on, and we should factor in the current domestic situation there. But it is simply not possible to steer clear of such a global power as the United States. We intend to do as much as the U.S. itself is ready for.

**Vitaly Naumkin:** In conclusion, I would like to ask the last one.

During these four days, we have discussed various issues related to the current state of the world order and

made a firm conclusion that it is undergoing a crisis and the future global order will be established with an increasing role of Asian countries.

How do you see this future global order?

**Vladimir Putin:** The existing system of international relations, international institutions and structures took shape following World War II as its result. The situation around the globe is changing drastically, both in Europe and on the American continent, with new rapidly growing and developing players, as well as in Africa, and, of course, Asia.

For the existing system and its institutions to last, it has to correspond to the realities of the ever-changing world. I believe that we must not destroy what has been created in the past decades, but should gradually transform it and adapt it to these realities, with due consideration of the growing power and prospects of Asia's development in general and certain Asian countries in particular. They certainly have the right to and must take the place they deserve in global politics and international affairs.

## Russia Rules Against Carbon Emission Penalties

As reported in an October 17 [article](#) in *The Moscow Times*, “Russia Rejects Climate Change Plan After Business Uproar,” the Russian government has reversed policy and acted to block proposed “climate change” legislation which would have imposed on Russia the same type of anti-industrial “green” insanity that is now prevalent throughout most of the European Union membership. The climate change legislation would have imposed mandatory quotas on carbon emissions for Russia’s largest companies, penalties for the biggest “polluters,” and established a new national carbon trading system. This has now all been scrapped.

Originally, the Russian government proposed introducing climate legislation in two phases. The first was to have been a five-year stock-taking exercise to measure company-level emissions and determine appropriate quotas for reducing emissions. After that,

the mandatory penalties cited above would have been imposed, together with the carbon trading scheme. This second, punitive stage has now been killed. *The Moscow Times* reported,

Plans for quotas on carbon emissions at Russia’s largest companies, a new national carbon trading system and penalties for the biggest [greenhouse gas] polluters have now been scrapped.

Instead, Russia will only go ahead with proposals to measure and collect data on emissions as part of a five-year green audit.

The campaign against a stricter package of measures was led by the influential Russian Union of Industrialists and Entrepreneurs (RSPP)—an organization that acts as the voice for many of Russia’s large industries and manufacturing concerns. The new laws were set to be introduced as part of Russia’s ratification of the 2016 Paris Climate Agreement. Now, that will not happen.

SUBSCRIBE TO

# EIR Executive Intelligence Review

## EIR Online



**EIR Online** gives subscribers one of the most valuable publications for policymakers—the weekly journal that has established Lyndon LaRouche as the most authoritative economic forecaster in the world today. Through this publication and the sharp interventions of the LaRouche Movement, we are changing politics worldwide, day by day.

EIR Online includes the entire magazine in PDF form, plus up-to-the-minute world news.

### EIR DAILY ALERT SERVICE

EIR's new Daily Alert Service provides critical news updates and analysis, based on EIR's 40-year unparalleled track record in covering global developments.



SUBSCRIBE (e-mail address must be provided.)

### EIR Online

- \$ 360 for one year
- \$ 180 for six months
- \$ 120 for four months
- \$ 90 for three months
- \$ 60 for two months

### EIR DAILY ALERT SERVICE

- \$ 100 one month (introductory)
- \$ 600 six months
- \$ 1,200 one year (includes EIR Online)

For mobile users, EIR and EIR Daily Alert Service are available in html

Name \_\_\_\_\_

Company \_\_\_\_\_

Address \_\_\_\_\_

City \_\_\_\_\_ State \_\_\_\_\_ Zip \_\_\_\_\_ Country \_\_\_\_\_

Phone ( \_\_\_\_\_ ) \_\_\_\_\_

E-mail \_\_\_\_\_

I enclose \$ \_\_\_\_\_ check or money order

Make checks payable to  
**EIR News Service Inc.**  
 P.O. Box 17390, Washington, D.C. 20041-0390

Please charge my  MasterCard  Visa  
 Discover  Am Ex

Card Number \_\_\_\_\_

Signature \_\_\_\_\_

Expiration Date \_\_\_\_\_

EIR can be reached at: [www.larouchepub.com/eiw](http://www.larouchepub.com/eiw)  
e-mail: [fulfillment@larouchepub.com](mailto:fulfillment@larouchepub.com) Call 1-800-278-3135 (toll-free)