

Draft Platform for 2008

The intention which is both expressed by, and underlies our 1776 Declaration of Independence and Federal Constitution, is implicitly embedded in the texts in which the history of the origins, founding, and continued existence of our republic is embedded, and combined to form virtually a single living testament. In each time our nation's habit of folly has imperilled the continued existence of this republic, the hand of our history has reached out to those leaders who acted to inspire a resumption of the principles upon which the roots and forms of our republic have depended.

We have now entered an awfully perilous trial of our republic's ability to continue to exist. We could now recover to survive once again, but to accomplish that, we must make a radical change from our recently erring ways. The correction of this current state of most perilous error must reflect a cultivated sense of the true origins, history, and future prospects of our republic, and of the world in which this once great republic, in its time, came into being as a temple of liberty and beacon of hope for all mankind.

That great republic from our past, was crafted chiefly out of the inspiration of those who came here from Europe, by those whose aim was to realize the principles and aspirations of the best fruits of the history of European civilization, but to do this in a place as distant as possible from the morally corrupting reach of the oligarchical traditions which have dominated European systems of government and social life in Europe itself, even, to a large degree, to the present day.

The 1763-1776 break of our patriots from the British system, was prompted by the repressive actions to which the English colonies in North America were subjected, that under the new imperial authority which the February 1763 Peace of Paris conferred upon the imperialist financier-oligarchical powers of the Anglo-Dutch Liberal party's British East India Company.² Such is the prompting of the reflection we find in

2. The Anglo-Dutch Liberal variety of financier-oligarchical faction were the fruit of the Liberal reforms led by Venice's Paolo Sarpi. Sarpi effected the transfer of the center of the Venetian financier-oligarchy's power to northern Europe, by taking over the maritime power built up within the Netherlands and Britain, step by step, as with his influence over the court of England's James I. The rape of England by the ogre William of Orange, led, through a series of wars, including the so-called "Seven Years" war, into a mutual weakening among the nations of continental Europe, which enabled the Anglo-Dutch faction of Sarpi's and William of Orange's heirs to obtain *de facto* imperial power, for what was then the British East India Company, during the course of the Eighteenth Century, from February 1763 on. During that century, and deep into the Nineteenth Century, what was, in fact, the neo-Venetian form of the British East India Company, actually exerted the principal elements of military, diplomatic, and other power, as against India and China, and into the Americas, a power which was deployed abroad in the nominal interest of the British monarchy. It was the agents of the British East India

our 1776 Declaration of Independence.

The roots of our republic were planted, chiefly, by Europeans who, as typified by the Winthrops and Mathers of Seventeenth-Century Massachusetts, not only brought the best of European republican culture, including the influence of Gottfried Leibniz, into the new settlements in North America, but treasured that cultural heritage by moving it to a relatively safe distance from the oligarchical traditions reigning in "Old Europe." In that way, our image of a republic was traced by our founders to the image of Plato and the better times of Athens of the tradition of Solon, to times prior to the Sophist follies of the Age of Pericles.

At the time we established our young new republic, we enjoyed not only the commitment to freedom which many leading Europeans admired in their view of our efforts; but, unfortunately, London's orchestration of the follies of the French Revolution, and the follies of a Habsburg Emperor Joseph II driven into impassioned unreason by the Martinist freemasonry's persecution and guillotining of his sister Marie Antoinette,³ made a moral ruin of continental Europe of July 1789 through the 1815 Congress of Vienna. Metternich and Castlereagh triumphed over Europe, with disgusting effects from which Europe has not been fully liberated to the present day.

So, from 1815 until 1865, our young U.S. republic remained at peril, threatened by London's agents deployed against us from without and, as the influence of Aaron Burr and his circles attests, within our borders. The notable assassinations of our sitting Presidents, actions dispatched from Europe, typify that source of peril.⁴

Company in North America, who formed what became known as the "American Tory" faction of traitor Aaron Burr of the Bank of Manhattan, and his associates, in the U.S.A., to the present day. This Anglo-Dutch Liberal financier interest, continues to be associated with the name of "Wall Street" since 1789. Beaverbrook heir Rupert Murdoch's acquisition of the *Wall Street Journal*, really rubs it in for every one of our witting patriots of today. Philosophical Liberalism is premised on a systemic rejection of any true moral principle, in favor of what John Locke, Bernard Mandeville, David Hume, François Quesnay, Turgot, Adam Smith, and the British Foreign Office's Jeremy Bentham and his followers, have defined as the essentially statistical, misanthropic, Anglo-Dutch Liberal misconception of "human nature."

3. I.e., the "Queen's necklace" affair orchestrated by the British Foreign Office's assets among the Martinist freemasonry.

4. Those who would discover the true historical roots of our nation's constitutional legacy, should recall the "four score and seven years" ago, of President Lincoln's Gettysburg Address. Lincoln was born on February 12, 1809. At the time of the launching of war against the U.S.A. by Britain's Confederacy puppet, there were still living citizens born at the time of the George Washington Presidency and Treasury Secretary Alexander Hamilton's crafting of our republic's economic policies. Similarly, the connections to youth-

Nonetheless, the aftermath of the great victory, led by President Abraham Lincoln, over London's attempt to destroy us, has been severely injured, but not yet ruined, even by assassinations of our Presidents or foulness of a kindred disposition. Generations of the descendants of our founders, from the early Seventeenth Century on, and a spirit of freedom adopted by so many of our immigrants, remain the principal well-spring of a living patriotic tradition which we must treasure once again today. So, despite all of the various forms of accumulated corruption of our society now, our constitutional republic remains, in principle, something very special as a factor of advantage to all humanity, still today, even as this was more clearly true in a happier time under the leadership of President Franklin Roosevelt.

Today, it would be to our ultimate advantage to confess that, politically, morally, and economically, we are a piece of wreckage, a state of moral and physical ruin of that which had been largely the accumulation of developments which had occurred since the nobler time before the death of our President Franklin Roosevelt. Nonetheless, human beings are not born as simply repetitions of the species and varieties of their ancestors. We must consider the fact, that we are embodiments of an accumulated, immortal cultural heritage, whose influence reaches, as in the consciousness of the living, to no less than three or more generations before us, and for those of us who enjoy certain cultural advantages, to traditions which we know as embedded within us personally from two or more centuries before our time.

Thus, in that way, we have a memory of ourselves and our nation as a true republic, reaching back two and a half centuries, or more, to as far back as the Winthrops and Mathers of Seventeenth-Century New England. Those of us who have the advantage of being better educated, trace this legacy to the ancient Greece of the Pythagoreans, Solon, and Plato, and see us as a continued embodiment of that particular cultural legacy.

On this account, our legacy is, that we of the U.S.A. are chiefly of Christian or Jewish heritage, the latter that of those Moseses known as Moses of Egypt and Sinai, Moses Maimonides, and Moses Mendelssohn, or, for others among us, as the current Pope Benedict XVI has lately emphasized, the living Jesus of Nazareth. Yet, at the same time, like Nicholas

ful leaders of our struggle for liberty were alive and influential among us during the time of the John Quincy Adams Presidency, he a leading figure of our political system up to the moment of his death in 1848. My own grandparents were born during the 1860s period of the Civil War, and I came to adulthood during the period of the Great Depression and the Second World War, with a memory of a relevant Quaker ancestor, and civil rights leader, a great-great grandfather, born about a decade before Lincoln. President Franklin Roosevelt's tradition was traced to an ancestor, banker Isaac Roosevelt, who had been an ally of Alexander Hamilton. Essentially, the political and cultural legacy of our founders dates from the first half of the Seventeenth Century in Massachusetts, when many of the seeds of our republic were sown in crucially important developments within that colony.

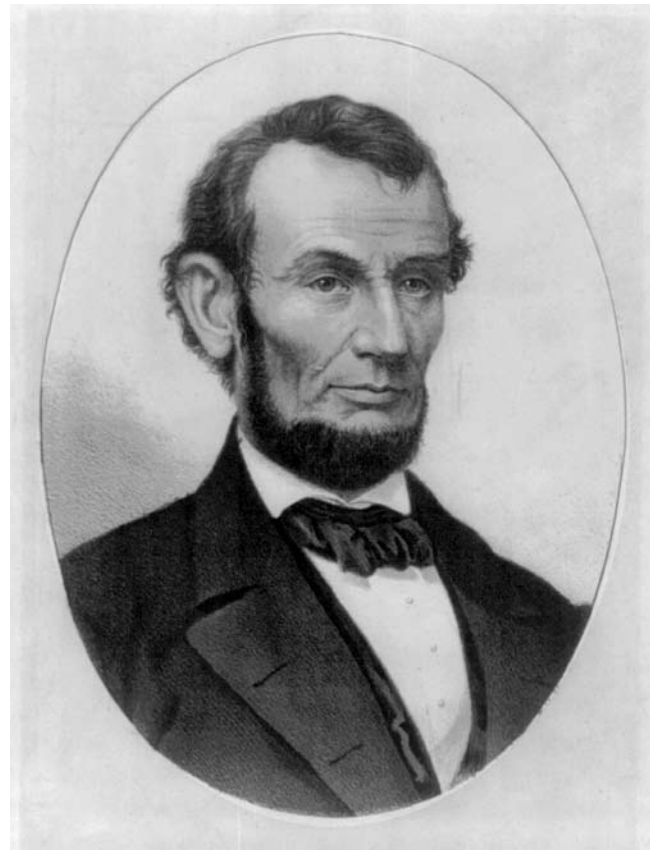

The name "geopolitics" was introduced to global strategies as part of a British imperial reaction to the victory of the U.S.A. led by President Abraham Lincoln over the British Empire's Confederacy puppet.

of Cusa and Philo of Alexandria, earlier, we are ecumenical in our best representatives' traditional view of the obligations we incur toward others, universally, by virtue of an informed insight into the essentially good nature of man. This heritage is expressed in the insertion of Leibniz's principle of *the pursuit of happiness* in our Declaration of Independence, and the echo of that as the supreme Preamble of our Federal Constitution. As our political forebears Cotton Mather and Benjamin Franklin reflected this: if we are true patriots of our republic, we must see ourselves as committed to "do good."

In respect to all of the foregoing considerations, we know we are mortal. This knowledge suggests to the wise the importance of "laying up treasures in Heaven," a sentiment which has tended to be mislaid among what are the currently relatively older generations which might be recognized as the usual sort of "middle class" of "white-collar" households' origin, or of pretensions to similar effect. When Sophistry adopts the trappings of the Frankfurt-School-style existentialism of Europe's Congress for Cultural Freedom (CCF), an existentialism which was widely instilled into our own "white-collar" generation born here between 1945 and 1958, any moral

commitment to the future outcome of one's own existence is, at best, somewhat impaired. Whereas, our respectable patriots were formerly accustomed to think in terms of families of children, parents, grandparents, and, sometimes, great-grandparents; that sense of multi-generational national destiny has tended, lately, to seem to be lost from the perspectives met among that generation.

On this account, in these recent times, there has been an existentially menacing cleavage between the policy-shaping outlooks of the older adult generation of the "white-collar," "Baby-Boomer" tradition, in opposition to the sense of the imperatives of the prospective future, as the current situation is sensed by young adults of the 18-35 years age-interval. Thus, that still living remnant of that much older generation now dying out, my own generation, had thought in terms of long-range capital improvements in the physical productivity and related potential of generations to come: a perspective which has been lost among the majority of the Baby-Boomer generation in public office, or comparable status, today.

Whereas, now, as witnessed as the fall-off in physical capital improvements in scientific-technological progress and infrastructure over the recent thirty-nine years, the so-called "Baby-Boomer" generations of North America and western and central Europe have lost the practical sense of a future for their own nation, or mankind in general. As a result of that recent demoralization of many among us, now, we see that the members of the poorer classes so affected, often pray for an escape from reality, into a place of safety beyond the "Hell Fires" of Armageddon; whereas, the Liberal middle-class types express a contrasting yearning for the gentler inanities of a serene, deathly state of imagined nothingness, which might pass for Purgatory.

1. The Matter of Money

As far back as we know of daily experience within the pores of European civilization since about 2,800 years ago, this history has been polluted by the influence of a certain, pathetic notion of "money." That moral pollution is commonly identified today, in other words, as the teaching and practice of "monetarism." The intellectual pollution has been a leading source of all our recent, presently worsening, and threatened economic, moral, and environmental disasters.

We may trace the roots of this, our present moral affliction, to, for example, the case of ancient Tyre as the leading enemy of the Mediterranean littoral's civilization, about 700 B.C. and later. Focus, in this way, upon the site of the complex of the ancient Delphi Apollo cult, tracing the road down to the sea. Flanking the temple itself, there is a collection of smaller structures called treasuries, representing the monetary wealth of sundry cities of Greece. From the access to the sea, the "loan-sharking" from Delphi leads to locations such as the penetration and subversion of the Etruscan culture at the mouth of the

Tiber, and up to the famous seven Latin hills above. Delphi itself is otherwise identified with the brutally oppressive law of Lycurgan Sparta, with its practice of helotry.

The dominant strategic role of usury, again, today, had already permeated most of the history of European civilization and its maritime cultures from those ancient times, through the time of the role of Venice's control over the medieval system of the Norman chivalry's rampages, and through the rise of modern Anglo-Dutch Liberal imperial maritime hegemonies such as that which, once again, has dominated the world increasingly, especially so since the virtually treasonous, 1971-1972 destruction of the role of the U.S. dollar as the pillar of a fixed-exchange-rate system of international credit.

This relationship between monetarism and imperial, or proto-imperial forms of maritime power, typified by the modern British imperial tradition, has been the root of the major wars of European civilization throughout the indicated period of history to the present date. Since the rise of Britain's Prince Edward Albert to power under his mother's nominal primacy, during the later decades of the Nineteenth Century, the issue of the imperial role of maritime power has been named "geopolitics." It had been, also, in fact, the pivotal issue of imperial conflicts from the time of ancient Tyre's conflict with a resurgent Egypt and Egypt's Ionian and Etruscan maritime allies.

To understand world history of the recent century and a half to date, it is essential to know that the name "geopolitics" was introduced to global strategies as part of a British imperial reaction to the aftermath of the victory of the U.S.A. led by Abraham Lincoln over the British Empire's Confederacy puppet.

President Lincoln had followed the policy-map which had been laid out with considerable precision by John Quincy Adams, during Adams' role in pre-defining the intended borders of a continental U.S. Republic, during his service as Secretary of State. The subsequent, great economic achievements of the U.S.A., under President Abraham Lincoln and beyond, in development of the productive powers of labor, were essentially inseparable from the integration of the U.S.'s territory as a continental nation, through aid of transcontinental railway development, and revolutionized the world at large. The American System of political-economy's achievements since the election of President Lincoln, inspired an attempted, great, beneficial change in the chosen destinies of Germany, France, Russia, Japan, and others.

However, the promotion of transcontinental and related railway networks throughout continental Eurasia, was seen by a war-like imperial London as a threat to the imperial hegemony of the Anglo-Dutch Liberal form of financier-oligarchical maritime supremacy.

This was the core issue of what are registered as having been World Wars I and II.

Thus, the ouster of Bismarck from the post of Germany's Chancellor, cleared the way for Britain's guilty Prince Edward Albert to organize World War I through using the silly Austro-Hungarian Kaiser as a tool for putting the Prince's

nephews, Germany's Kaiser Wilhelm II and Russia's Czar Nicholas II, at each others' throats through London-directed Balkan wars, as British interests orchestrated the later, new, continuing wave of Balkan wars launched on London's direction during the term of President George H.W. Bush.

Thus, the British had allied themselves with Japan for the launching of Japan's 1895-1945 wars against China, against Korea and Russia. Thus, a 1920s naval alliance of Britain and Japan against the naval power of the U.S., led, ironically, to Japan's attack on Pearl Harbor. That conflict has been named "geopolitics." "Geopolitics," so defined, has remained the imperial war-like and related policy of London, as best typified lately by the cases of the Margaret Thatcher and Tony Blair ministries.

Now, a new page in world economic history is being turned.

The two great "geopolitical" challenges now are, first, the fact that the growth of population, and the related needs for development of raw-materials resources, requires a sudden great expansion of the development of territories, a surge in advanced technologies, and also new, fundamental discoveries of principles in physical science. The strategic situation is therefore typified currently, by the present urgency of developing at least five and more nuclear-fission power plants per day on this planet, and by the need for a new quality of global network of land-based mass transportation, which will replace much of the dependency on sea-borne and highway transport, especially for the transport of relatively high-value-per-ton classes of freight.

This set of circumstances has led, presently, to the adoption of a mission for development of a Bering Strait railway (or magnetic levitation) transport tunnel, from Uelen in Russia's Siberia, to Alaska. Such a transport route, would be an extension of the Trans-Siberian Railway system, and would provide a crucially needed keystone for the development of transportation lines, implicitly, from the Atlantic coasts of Europe to the tip of South America. From Europe and Southwest Asia, this same network, as extended, would penetrate the African continent. The development of high-speed magnetic-levitation modes along these routes would make possible, and otherwise revolutionize the efficiency of the world economy along, principally, these land-routes. Immediately, it would open the way for the needed development of regions of the world which must be developed to meet the greatly expanded requirements for development of raw-materials resources.

This would also facilitate a presently much-needed shift from costly dependency upon transport of hydrocarbon fuels, a shift which would be accomplished now through the use of high-temperature gas-cooled nuclear-power reactors of suitable design, for the production of cleaner, hydrogen-based fuels from water. Carbon-based fuels would be relegated, thus, to their more useful role as raw materials of production and support of life, consumed in production of more valuable products-per-ton near the source of extraction. Long-range

high-priced cost of transport of cheap materials would be greatly reduced, with a resulting great saving, and increase of rates of productivity, per capita, and per square kilometer, for the nations and populations of the world at large.

The combination of such economic-development measures would lead to an early and rapid increase in the productive powers of labor and average standard of living, in principally two ways. The relative physical cost of production would be lowered, by resort to more efficient modes, and the relative standard of living generated per capita, would be increased through a continuing shift toward higher rates of concentration of costs and investments, in increasingly capital-intensive modes of higher-energy-flux-density modes of technological progress in the productive powers of labor itself. These are absolutely indispensable changes in practice now needed for a secure future of this planet as a whole.

These considerations have a powerful impact on the way in which our own government, and others, should think about money. It is time to send the practice of usury, including monetarist dogmas, into permanent retirement in a place where such intrinsically immoral practices shall repose forever in harmless innocence. It is time for the world at large to adopt and employ what U.S. Treasury Secretary Alexander Hamilton named "the American System of political-economy," on this account, rather than an intrinsically imperialist monetarist system associated with the practices of the presently self-doomed British system of political-economy.

The proper way to think about money and monetary policies now, was already developed, with relative uniqueness among all nations, by both the crafting of the U.S. Constitution itself, and the exemplary leading role of Alexander Hamilton as the first U.S. Secretary of the Treasury. The task, at this immediate point in these theses as a whole, is to restate the case for the principles underlying that American System of political-economy, that in terms of contemporary relevance.

1.10 The British Cult of Usury

The leading cause for the awful threat to civilization, globally, today, is a shift away from the pre-1971 fixed-exchange-rate monetary system which had been launched as a phase of the economic recovery effected through the leadership of the U.S. Administration of Franklin Roosevelt. To understand the economic and related problems menacing civilization as a whole at this present moment, it is necessary to recognize that the 1971-1972 wrecking of the Bretton Woods system, on the initiative of the U.S. Nixon Administration, was no more than a crucial phase of inflection in a radical, downward turn in U.S. policy set into motion by the assassination of U.S. President John F. Kennedy and the subsequent launching of an Indo-China war through the fraudulent pretext known as "The Gulf of Tonkin" resolution.

The effective outcome of those changes of the 1963-1972 interval, has been a subsequent, multi-generational process of transfer of power to the old British-imperial world-system un-

FIGURE 2

Main Lines of a Worldwide Rail Network, as Sketched by H.A. Cooper

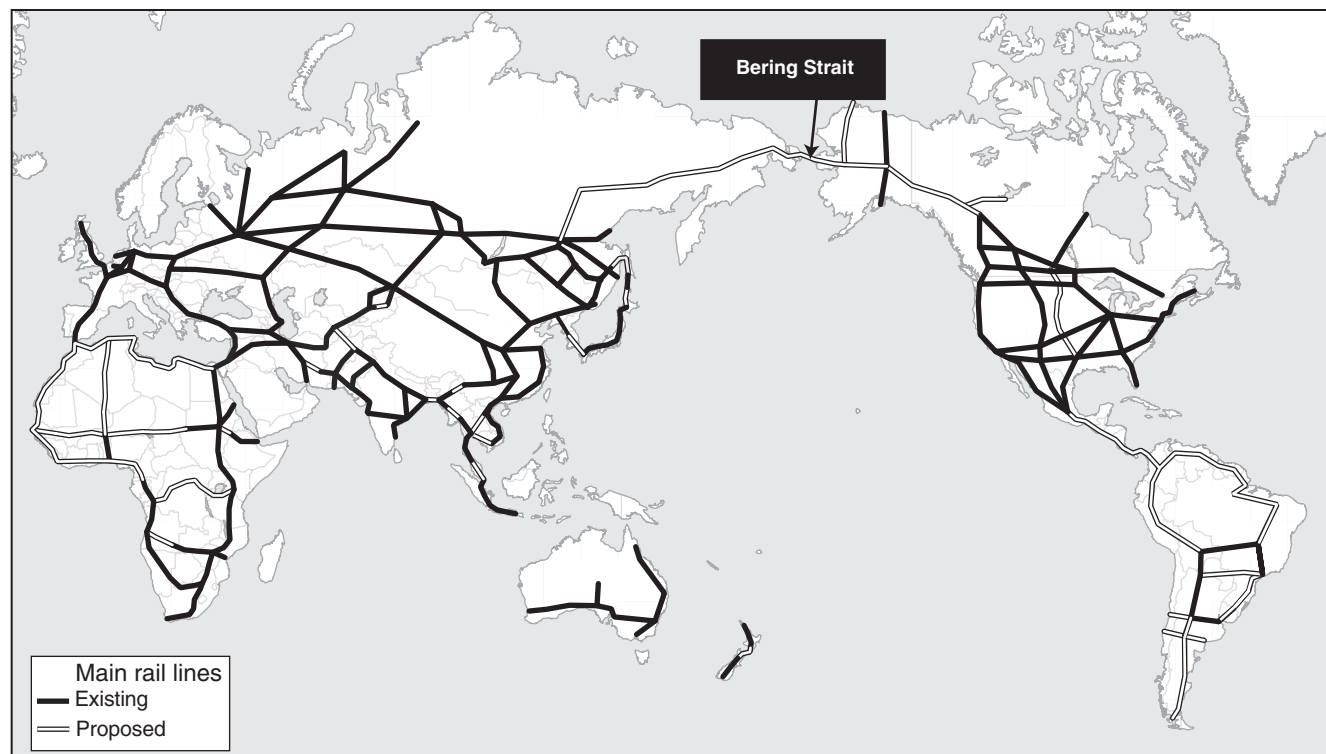

der the new names for that imperialism, such as “globalization” and “environmentalism.” It is old British imperialism disguised by its wearing a new rag. This new imperialism is the circumstance in which our U.S. republic, and virtually all of the world besides, has been dragged to the verge of a threatened general monetary-economic breakdown-crisis of the quality which might be described as something comparable to Europe’s Fourteenth-Century “New Dark Age.”

The operative word for identifying this degeneration of the world’s economic and strategic situation is “usury.” Formally, the replacement of economic sanity by a return to a practice of usury was accomplished by the influence of the Trilateral Commission over the U.S. Carter Administration, during 1977-1981. Actually, usury had already been reintroduced to global monetary-economic dynamics with the 1971-1972 plunge of the U.S.A. into a “floating-exchange-rate” monetary order.⁵

5. At the close of 1995 and beginning of 1996, I defined the usury-driven decay of the U.S. and other economies by a pedagogical device which I identified as a “triple-curve” form of the recent and currently ongoing slide of the U.S., in particular, into a breakdown-crisis with certain similarities to the 1923 hyperinflationary crisis of Weimar Germany. My calculations explicitly referenced the developments which became visible in the U.S.A. during the 1977-1981 Carter Administration. Actually, the lawful process which the data from that period reflected, had begun under President Nixon, especially with the role of that Nixon Administration’s George W. Shultz in orchestrating the breakup of the Bretton Woods system.

Usury is an old, and intrinsically ever-evil practice, but the specific, historically relevant form of that practice of usury for today, is, chiefly, the idea of money-value associated with the special influence of Venice’s Paolo Sarpi and his dupes.

The Liberal model, introduced as a certain kind of revolution in Venetian strategy, by Paolo Sarpi, is to be viewed as a qualitatively new phase of development in a long history of what was known, since ancient times, as “the oligarchical model.” The old oligarchical model, which Sarpi’s reforms superseded, was that which is associated with the depraved tyranny of ancient Babylon, with the so-called “Persian” Empire, the Roman Empire, Byzantium, and the so-called *ultramontane* system of shared Venetian and Norman medieval ruin and rule.

That presently most relevant, Anglo-Dutch Liberal system of modern financier rule, is a modern innovation in the form of imperialism. This innovation was developed by the influence of Sarpi, and by the notable assistance of his personal lackey Galileo Galilei. That use of the term “Liberal” as a term for a certain kind of social-political system, signifies a banning, as by the notorious enemy of the U.S.A., Adam Smith, of any actually systemic principle in human relations, whether within or among societies.⁶

6. Adam Smith’s 1776 publication, the so-called *Wealth of Nations*, was a shameless expression of British Liberal’s hatred against the United States of



Kurchatov Institute

The shift from dependence on hydrocarbon fuels requires widespread use of the high-temperature gas-cooled reactor (HTGR). Shown here is a study of the HTGR technology at Moscow's Kurchatov Institute. This core design is similar to the pebble-bed model, now being built in South Africa

In modern British culture since the accession of James I, the term “Liberal” signifies, essentially, and precisely, the virtual elimination of moral considerations based on universal principles. In such a system, rules, based on no actual principle, are introduced, and often brutally enforced, as pragmatic rules of the moment: rules chosen for estimated expediency of the moment, therefore, not as principles in the same sense as the notion of universal physical-scientific principles. The empiricists John Locke, Bernard Mandeville, David Hume, Adam Smith, and Jeremy Bentham, are all more or less equally typical of this essentially unprincipled, Cartesian-like notion of public policy within and among nations.

This lack of rational rules of monetary and other economically relevant behavior, has created a British system of modern monetarism which is not merely utterly irrational, but is a degrading system of usury, which degrades the notion of economic value to the lunatic antics of a giant gambling casino,

America at that time. The content of Smith's own text attests flagrantly to that fact.

with no efficient regard for determining the relatively greater or lesser value of production and trade for specifically human objectives.

However, that issue of the notion of value, aside, to be treated at a point below, the point immediately at hand here, is, that, despite the wishful estimate of Lord Shelburne's lackey Gibbon, the British Empire will pass away of its own doing, probably, on an historical scale, very soon. It will pass like all of the empires which European civilization has experienced as earlier expressions of the influence of the ancient oligarchical model. It, too, will go, and, according to current signs of its morbidity, soon; the choice left to us, notably in the U.S.A., is to take steps to ensure that our republic is not swept from the world map together with the presently self-foredoomed British empire.⁷

The old, pre-Sarpi, medieval European feudal system of usury, was the medieval model which went belly-up in the chain-reaction bankruptcy of the Lombard banking system during the middle of Europe's Fourteenth Century. However, since George Shultz's guiding of the Nixon Administration into the inflationary wrecking of the fixed-exchange-rate system, and the subsequent installation of Trilateral Commission doctrine under Zbigniew Brzezinski's James Earl Carter Presidency, certain essential features of that ancient feudal insanity, far worse than any mere “John Law”-style financial bubble, began to be copied into what has become the present, terminal form of the presently collapsing monetary system of hedge funds and the like. This presently hyperinflationary, rabid condition of the world's monetary-financial systems generally, is an exceptional, fatefully, now, very temporary development within modern Europe, a very much temporary, and, in fact, also terminal phase of a dying system.

To address the matter of a longer-term prospect for a truly modern monetary theory as such, we must turn attention to the roots of the economic problems which preceded the disastrous, usury-driven changes of the 1971-1981 interval. We must focus on the perils also inhering in any prospect of return to the less rambunctious form of the ruinous monetarist practices prior to the 1929-style, October 1987 Wall Street crisis.

To understand why and how the evil of Sarpi's Liberalism came to supersede that of the old, medieval form of usury under Venice and the Norman chivalry, we must first recognize the special, new conditions in which the religious warfare of 1492-1648 came into being, and were developed. One of the most carefully studied of the writings which point out the underlying nature of these new conditions of warfare, has been Niccolò Machiavelli's *Discourses on the First Ten Books of Titus Livius*, one among the most influential writings on the origins of modern military strategy. That book points to those new features of modern European civilization which ruined

7. When the Asian intruder, the Delphic Apollo, sliced up the goddess Gaea's companion Python, it is not implied that the Satan-like serpent Python surrendered without a boisterous struggle.

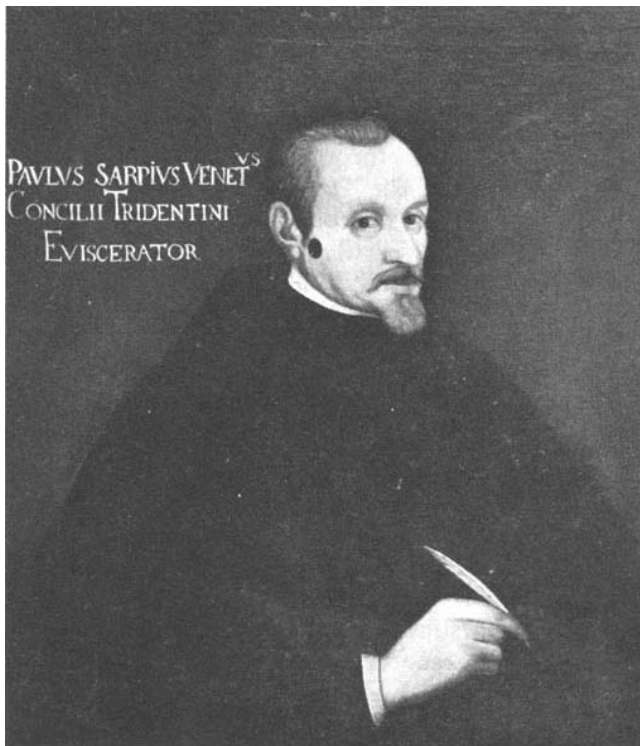

Paolo Sarpi (1552-1623) introduced a kind of revolution in Venetian strategy. The ancient oligarchical model was no longer effective, so he developed the Liberal model, which became the Anglo-Dutch Liberal system we know today.

the Habsburgs' and related campaigns against the continuing influence of the great ecumenical Council of Florence. It was this challenge to which Sarpi's Liberal reform of the imperialist system responded.

1.11 Paolo Sarpi's System

Contrary to Aristotle, there is no *tabula rasa* which should be permitted to serve as a factor in shaping an account of the real history of our universe, nor in competent political science's efforts to understand the moment of world history within which today's people with very short memories presently find themselves. All of the changes inhering in the distant historical past, which extends, implicitly, to the time before a fast-moving, younger Sun had spun off the Solar system, have left deeply embedded, and powerfully influential effects of their heritage within all parts of contemporary humanity.

In respect to European culture today, which is a very distinct, and relatively most recent phenomenon in culture generally, this has deep roots in hundreds of millennia before any specifically European ancestor existed. Admittedly, many silly fellows today insist, that to qualify as a citizen, it were sufficient to be created as if out of mud only yesterday, and to be equipped, thus, with the magical blessings of combined common sense and ignorance, thus empowered to pass snap judg-

ment on any conceivable issue of current political strife. To the contrary, in reality, as careful studies of the results of opinion-polls, and the perilous condition of many thousands of U.S. bridges, should have warned us, nations or cultures, and, certainly, governments, which hold to such short-sighted opinions, are not likely to survive for very long, especially under the awesome global conditions which are onrushing today.

The actual threat which most greatly menaced the medieval minds of modern Venice and its Habsburgs, as during the 1492-1648 interval, was the modern sovereign nation-state, such as Louis XI's France or Henry VII's England, which was, in all of its essential distinctions, a new form of society which was, more or less tenderly, digging the graves of the old. This was the new form of society which was introduced during Europe's Fifteenth-Century Renaissance, through the prompting of two exceptionally influential works of Cardinal Nicholas of Cusa, his *Concordantia Catholica*, and his *De Docta Ignorantia*. The first of these writings defined the principled basis for the establishment of a new quality of organization of society, into sovereign nation-state republics of the type which became known to modern Europe as the model *commonwealths* of Louis XI's France and Henry VII's England. The second, *De Docta Ignorantia*, became the keystone of a series of scientific papers on which the principal line of progress of modern, and also viable European science depended: that best typified by the work of Cusa himself, Luca Pacioli, Leonardo da Vinci, Johannes Kepler, Pierre de Fermat, Gottfried Leibniz, Carl F. Gauss, and Bernhard Riemann.

Before that Renaissance, the known condition of mankind generally had been associated, chiefly, with a division of societies between a ruling oligarchy and its lackeys at the top, and a larger mass of the population, the under-classes, which were subjected to the virtual status of human cattle.

As the work of the founders of the Massachusetts Bay Colony, the Winthrops and Mathers, shows, and as the work of their Promethean follower Benjamin Franklin attests, our republic is premised on the intentions associated with the influence of Cusa and his notable intellectual followers. Although much of this virtue has been assimilated in the development of modern Europe, and elsewhere, the development of the U.S. republic has been, its warts and all, the prime precedent for establishing sovereign states of the type from which our Constitution has expelled the relics of oligarchical class-supremacy (such as forms of *lèse majesté* and titled oligarchy) over the so-called lower classes of society. The founding of our republic under this notion from that Renaissance, has become the historical marker for a modern political and social order premised upon the principle of true freedom of the individual human soul, the freedom of men and women to become the "fire-bringers" which that pro-satanic oligarch known as the Olympian Zeus would have tortured and banned.

The onset and immediate aftermath of the great ecumeni-

cal Council of Florence, which had virtually given a rebirth from a New Dark Age to the previously shattered Christian Papacy, briefly reconciled the conflict between the leaders of the Eastern and Western Christian churches, and, as Cardinal Nicholas of Cusa's *De Pace Fidei* attests, set forth the principles for an ecumenical peace between Christians and non-Christians, such as with, most clearly, Judaism and Islam, but not only Judaism and Islam. This great moment of modern history was spoiled, through the devilry of a resurgent Venetian financier oligarchy, which orchestrated the wave of religious wars triggered by the Fall of Constantinople. Despite that devilry, the great benefits accomplished by the architects of the great ecumenical council, survived in a large degree, to become the foundation of all the later true achievements of the nations of modern European civilization. However, all of the surviving accomplishments of the great Fifteenth-Century exit from medieval horrors into modern society, have been imperilled, and often greatly corrupted ones, to the present time.

The expulsion of the Jews from Spain, where religious peace among Christians, Jews, and Moslems had prevailed for a long time, was that act by the monstrous Grand Inquisitor Tomás de Torquemada which set off what became the monstrous religious warfare of the 1492-1648 interval. Behind Torquemada, was the same Venetian financier oligarchy which had established the imperial feudal power of the Habsburg dynasty.⁸ This was the same Venetian financier-oligarchy which, led, on the ground by Venice's spy-master Zorzi, personally orchestrated the corruption of England's Henry VIII, a turn by "girl-crazy" butcher Henry VIII which was intended to break up the peace among Spain, England, and France, through the break-up of Henry VIII's marriage by a pack of Venetian agents including Zorzi, Cardinal Pole, Thomas Cromwell, et al. These closely related developments in England and Spain, are key to understanding the role of the Habsburgs in orchestrating the monstrous outbreaks of Eu-



Jules Cardinal Mazarin's orchestration of the great 1648 Peace of Westphalia put an end to a century and a half of religious warfare, orchestrated by Venice. Here he is shown with Anne of Austria, Queen consort of King Louis XIII of France.

rope's internal religious warfare during the interval 1492-1648.

It was during that latter interval that a new system of oligarchical rule was introduced by Paolo Sarpi.

1.12 The Religious Wars

The general condition of religious and kindred warfare which has persisted, globally, since the Fall of Constantinople, to the present time, underwent a series of successive stages of development, the most significant of which, for our purposes today, hit western and central Europe during the span of the interval of Venice's orchestration of monstrous religious warfare, from the 1492 expulsion of the Jews from a Habsburg-controlled Spain,⁹ until Cardinal Mazarin's successful intervention on behalf of what became the great 1648 Peace of Westphalia.

In between those two dates, a revolution broke out within the ranks of the Venetian financier-oligarchy itself. The outcome of this was Paolo Sarpi's modernist victory over the opposing faction of the Venetian financier oligarchy, and the launching

of what became known as the modern philosophical-theological Liberalism from which the Anglo-Dutch Liberal system emerged to become that British Empire which exists as a leading, war-like power on this planet at large, to the present day.

To gain a competent insight into the still efficient roots of the development of our U.S. republic, the following summary clarification of the situation during the period between 1492 and 1648 is more or less indispensable.

The challenge which had prompted Venice to organize and promote the religious warfare of 1492-1648 throughout western and central Europe, was Venice's fear of, and hatred against the Council of Florence and its sequelae.

The most typical of these relevant sequels, were Cusa's launching of both modern statecraft and modern European science, and the emergence of the first modern sovereign

8. Torquemada was recognized as the model of the pro-Satanic "executioner" by the notorious Martinist freemason and creator of the personality of the Emperor Napoleon Bonaparte, Savoy's Count Joseph de Maistre. De Maistre was also the promoter of the Jacobin reign of terror, from whose ranks he lifted up Napoleon Bonaparte and gave him a newly programmed personality.

9. Although the Spanish monarchy of Isabella I and Fernando was nominally representative of the Trastamara dynasty, the faction of Grand Inquisitor Tomás de Torquemada and the Habsburgs had already taken control. The name Hapsburg is merely a Spanish-language or English-language attempt at speaking with an Austrian dialect. The Habsburg control expressed by Charles V and Philip II, and by the 1618-1648 Thirty Years War, was already taking over during the reign of Isabella and Fernando. Grand Inquisitor Torquemada is the key to understanding where and how the imperial Habsburg-Venetian control was exerted.



EIRNS/Dianne Bettag

Florence, seen from across the Arno River. The famous Cathedral, with the Dome constructed by Filippo Brunelleschi, is on the right.

nation-states based on the commonwealth principle, Louis XI's France and Henry VII's England. The birth and development of these two modern commonwealths, and the attempted emulation of this concept of the modern sovereign state, by Florence, an attempt in which Niccolò Machiavelli had participated as an official of secondary rank, were the source of the impetus of Machiavelli's post-1512 launching of his new, more famous career, as a great post-medieval thinker in the domain of modern warfare, a status which Machiavelli's work continued to enjoy in the training of the modern professional military officer corps of Europe and the Americas deep into the Twentieth Century.

The way in which that process unfolded remains crucial for understanding the roots of the modern world at large today. The setting is Florence.

The Florence we must consider, is that of the great reformer and backer of the Council of Florence Cosimo de' Medici, which is typified, on background, in that time, by the Filippo Brunelleschi who had discovered and applied the physical principle of the catenary, which he employed to craft the erection of the famous dome on Florence's Cathedral of Santa Maria del Fiore.¹⁰ Brunelleschi's genius was exceptional, as an experience of the acoustics of the Pazzi Chapel sings that message to the time of my last visit to that building; but, he was also typical of the production of many exceptional people of science and technology, by Florence of those times.

The greatest of those geniuses was Cardinal Nicholas of Cusa.

Study of the course and outcome of the 1492-1648 period of religious warfare, shows the perceptive historian that the crucial feature of the religious warfare unleashed by the Fall

of Constantinople, was not a conflict between mere religious dogmas as such, but was, rather, more profoundly existential. The great ecumenical Council of Florence had not been a mere rearrangement of the deck-chairs of society's rulers and management; it was an organic, dynamic change in the scientifically principled way in which the productive, and also the political forces of society were organized.

The following set of historical considerations is most notable here for its bearing on the way in which our republic came into being:

a.) Nicholas of Cusa's *Concordantia Catholica* was, in itself, not only the work which superseded Dante Alighieri's *De Monarchia* as a prospect for the replacement of the feudal *ultramontane* system by a national republic based on the common use of a shared, literate development of a language (e.g., Italian) universal within the bounds of that republic. Indeed, the public oral renditions, in the streets of Florence, of sections from Dante's *Commedia*, was a crucial factor in the development of the notion of the use of a literate form of Italian in creating the cultural integument required for the functioning of a true republic. A brutishly illiterate population is not the foundation for the institutions of a viable national republic.

b.) *Concordantia Catholica*'s prescription of a system of respectively sovereign republics based on a commonly unifying principle governing relations among sovereigns, was the indispensable prescription for the break-up of that form of tyranny which the discredited *ultramontane* system had represented.

On this account, the effect of the Papal council which took up the implications of the Nazi-like Norman crime in the trial and burning alive of Jeanne d'Arc, was integral to a series of the successive steps leading into the benefits of the subsequent great ecumenical Council of Florence. The case of Jeanne d'Arc was crucial for the later emergence of the first

10. Notably, Sarpi's lackey Galileo Galilei, never understood either the formal or the physical character of the catenary, nor did any among the leading enemies of Leibniz's work, to the present day.

modern nation-state of the Commonwealth form, that of France's Louis XI, but that development by Louis XI in France was crucial for the coming-into-being of the modern nation-state in Europe, and in the U.S.A., after that.¹¹

c.) Cusa's defense of science against the implicitly Satanic traditions of the Olympian Zeus and the Delphic Apollo-Dionysos cult in his *De Docta Ignorantia* was crucial. That founding of modern experimental physical science, by Cusa, was reflected in the sweeping social-economic reforms conducted by France under Louis XI, and in England under Louis's admirer Henry VII. These reforms engaged the middle class and peasantry which had been trapped within feudal society, in participation in the fostering of the conditions for scientific and technological progress. This freed the populations enjoying such benefits from what had been the tradition of a life of human cattle previously imposed upon the great majority of society's population.

d.) It was not religion which caused the religious warfare of 1492-1648. That warfare, as launched under the banner of Grand Inquisitor Tomás de Torquemada, was the war of the devil, the inquisitors, against the Creator. The relevant evil was the tradition of the Olympian Zeus, and the tradition of the Sophistry of the Delphi Apollo and Dionysos cults, which engaged itself in a fight for its survival against the principle of Mosaic *Genesis* 1: 26-29. It was a fight against a great evil, such as the evil of Torquemada which the Satanic Joseph de Maistre and his Nazi successors expressed later, as in the Hitler movement's seeking to purge continental Europe's culture of the great legacy of the Moses Mendelssohn who had contributed so greatly, in alliance with his friend Gotthold Lessing, against the gang associated with the decadent Leonhard Euler, which was working to ruin every cultural achievement to be recognized in the late Eighteenth- and Nineteenth-Century culture and prosperity of Germany.

Here, amid these far-reaching considerations, lies the significance of Niccolò Machiavelli's exploration of the historic significance for civilization today, of those issues of modern European military strategy.

The changes in economic and related culture which had spread from the cities such as Florence in Italy, and the commonwealth system of reforms of Louis XI and Henry VII, unleashed both the emergence of modern Europe's urban life and the related development of the countryside. This change, was typified so, as by the effort to establish a republic of Florence. This connection was well recognized among the veteran officers of the American Revolution in their composition of the Society of the Cincinnati on the basis of a study of Machiavelli's *Discourses on the First Ten Books of Livy*.

11. The disgusting reaction against Friedrich Schiller's dramatic presentation of Jeanne d'Arc, as by the depraved George Bernard Shaw and others, is not merely defense of the English feudal tradition, but was, in itself, an implicitly existentialist reflection of the systemic depravity inherent in the tradition of the British empire.



Niccolò Machiavelli's outline for the defense of the city of Florence against attacking reactionary forces, was the threat recognized by Sarpi. Machiavelli's studies were highly influential on those who fought and won the American Revolution.

So, when fondness for the fallen *ultramontane* system had summoned the evil of Venice to launch religious warfare against the accomplishments of the great ecumenical Council of Florence, the Venice-led Habsburg and other accomplices met a different quality of enemy in the resistance summoned by the newly developed republican spirit of the cities and countryside of Europe. In that setting, the challenge taken up by Sarpi can be summarized in the following richly relevant terms for consideration by us, here and now, today.

In reading Machiavelli's writings, notably his *Discourses on the First Ten Books of Livy*, it is essential to emphasize attention to the social policies implicit in Machiavelli's own argument there, and in relevant other locations. The Machiavelli of the period leading into 1512 A.D., was a product of a struggle for the establishment of the republic of Florence against the pro-medievalist reactionaries. His succinct treatment of the figure of Cincinnatus in the *Discourses*, as this connection is reflected in the adopted name of the veteran officers of the American Revolution, and his outline for the self-

defense of the modern urban society against the forces of the reactionary predators, are items which reflect the specific spark of military-strategic genius which was to become so highly respected in military professionals' education during later centuries.

In the emergence and development of modern industry prior to the reactionary destruction of our economy during and following the 1970s, there was a crucial, conspicuous point of cross-over from productive craftsmanship to scientific discovery of principle in agriculture, modern industry, and other respects. The same craftsmanship which is required for effective machine-tool design in industry, passes upward into a higher quality of productive action in the crafting of the apparatus needed to accomplish a truly crucial experimental test of principle.

We see a relevant trace of that connection in the development of economy and its technology in the Massachusetts Bay Colony of the interval prior to that suppression of the Colony's rights by England which occurred during 1688-1689. We see this demonstrated later in the role of Massachusetts-born Benjamin Franklin's emergence, as among the world's acknowledged leading and fertile scientific intellects during the course of his adult life. We see this also in the role of the so-called "Latin farmer" in the development of agriculture during the early decades of our young republic. Shifting our attention to earlier modern centuries, we witness a similar economic revolution, with leaps in productivity, in the reforms of France under Louis XI.

That is the social-political and physical-economic factor which prevented the Venetians' crushing of modern civilization during the late Sixteenth Century and beyond. This failure of old Venice's medieval tradition in modern circumstances, is what, to a large degree, fostered Sarpi's relative victory over his more traditionalist Venetian and related rivals of that time. It was the progress in proliferation of the benefits of scientific and technological progress among growing rations of the population, which produced the role of scientific, technological, and social-political progress in the resistance to the Venetian-led use of religious warfare during the 1492-1648 interval. Machiavelli's outline of the case for the self-defense of the city against attacking reactionary forces, was very much to this point. It was this latter factor, as recognized by Sarpi, which became the social-political foundation for the modern Liberalism of the Anglo-Dutch oligarchical faction, up to the present day. This is the key to understanding the reactionary motives of those who crafted the production of a generation of young white-collar spawn, the intrinsically dionysian "environmentalists," the so-called "68ers," for their continuing destruction of modern, capital-intensive scientific progress in production, still today.

Follow the traces of Sarpi and the Anglo-Dutch Liberals who followed his leadership.

Sarpi's Venetian faction recognized that it was the cultural and related effects of the realization of Cusa's revolution in

science and statecraft which have proven to create the fatal operational flaw in the Venetian strategy. As long as Venice clung to the Aristotelean doctrine against scientific progress, Venice was doomed either to fail utterly, or to bring down the entire society into a general form of a new dark age. Therefore, in Sarpi's view, the *apparent* key for Venice's solution for this paradox, lay in Sarpi's recognition of this flaw in the specific strategic-cultural significance of the inherently pro-oligarchist, current Aristotelean dogma.

On this account, Sarpi directed his intellectual attack against the relative restrictions inherent in the Norman-Venetian medievalists' form of the Crusaders' own Aristotelean legacy. At the same time, for this reason, Sarpi's circles feared the influence of the anti-Aristotelean Kepler's role as an extremely thorough and effective follower of Cusa and Leonardo da Vinci.

As the assigned role of Sarpi's lackey, Galileo Galilei, attests, Sarpi's own attack on Aristotle resurrected the dead soul of medievalist William of Ockham (aka "Occam"). The significance of Ockham for both Sarpi and his house-lackey Galileo, was that Ockham was the ideologue of an essentially insane, highly formalist system of what was purely Sophistry. This meant, for Sarpi, that he could thus correct the crucial strategic flaw of the Venetian faction's role in religious warfare, by permitting adoption of some among the technological

Toward a New Council of Florence

'On the Peace of Faith' and Other Works by Nicolaus of Cusa

Translations of seminal writings of the 15th-century Roman Catholic Cardinal Nicolaus of Cusa, who, through his work and writings, contributed more than anyone else to the launching of the European Golden Renaissance. The title of the book, *Toward a New Council of Florence*, expresses our purpose in publishing it: to spark a new Renaissance today.

- 12 works published for the first time in English
- New translations of 3 important works

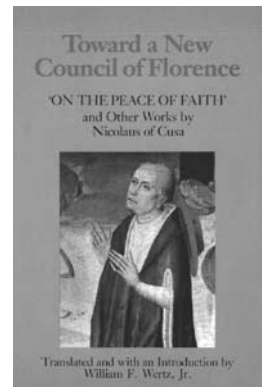

\$15

plus \$3.50 shipping and handling

Schiller Institute, Inc.

P.O. Box 20244 Washington, D.C. 20041-0244
phone: 703-771-8390 www.schillerinstitute.org

and social innovations used by the followers of the commonwealth cause, even as simplistic reifications of original discoveries made by Kepler, but without allowing the spread of the actually scientific method which Cusa et al. had revived from the circles of the ancient Pythagoreans and Plato's circles.

This, Sarpian view of the crucial strategic role of an Ockhamite philosophical revival, had the additional benefit for Sarpi's cause, of providing a design for the most irrational varieties of the doctrinal superstitions of some nominally Protestant ideologies, using this corruption to weaken both the sanity and the moral character of many ideological factions among the forces of Venice's adversaries. Such are the origins, with Sarpi's adoption of Ockham's irrationalism, of what became the Cartesianism whose methodological corruption persists within the Anglo-Dutch empiricism of even the present time. For example, we have the later depravities of the British Foreign Office's Jeremy Bentham and Lord Palmerston; we have, also, the British East India Company's Haileybury School; and the Nineteenth-Century proliferations of positivists and pragmatists as typified by Laplace, Cauchy, Clausius, Grassmann, Helmholtz, and the wild-eyed followers of Ernst Mach.

Sarpi accompanied his launching of the power of his Venetian faction, by a shift of emphasis toward the emerging maritime powers of northern Europe, as centered upon the British Isles and the Netherlands. Venice had ceased to be a

strategically secure position from which to take the kind of strategic control over Europe which it had commanded with its medieval Norman allies. The implied "New Venice" would be located, according to Sarpi, in the relatively more secure strategic base-positions in maritime northern Europe. With Sarpi's massive intervention into the affairs of the English monarchy, the character of the monarchy of James I was directly orchestrated by Sarpi channels which included such enemies of William Shakespeare as Sir Francis Bacon and Galileo's pupil Thomas Hobbes.¹² What followed, was the weakening of France and the boosting of the power of an Anglo-Dutch Liberal "New Venice" as a potentially imperial maritime power.

This trend, as set into motion by Sarpi and his faction, was summed up in a 1618-1648 Thirty Years War which, in principle, was chiefly the handiwork of Sarpi's influence, rather than Sarpi's foolish Spanish and Austrian Habsburg dupes. With the rape of England by William of Orange, the process set into motion by Sarpi, of launching the series of continental wars which would clear the way for building an Anglo-Dutch Liberal empire (with Venice in the background) was under way. With the completion of the Hannoverian succession, upon the death of Queen Anne, as Graham Lowry has presented the evidence, the campaign to eradicate the leading influence of Gottfried Leibniz from the pages of European science, was under way.¹³ A great period of Anglo-Dutch moral depravity, and orchestrated continental wars, prepared the way for the emergence of an empire of the British East India Company with that February 1763 Peace of Paris, which unleashed London's intention to crush and loot its own colonies in North America. The process of confrontation leading toward the 1776 U.S. Declaration of Independence, was on the way.

12. Admittedly, Venice's modern interventions against the English monarch under Henry VIII, were conducted under the coordination of Zorzi (aka "Giorgi"), then operating within England in the role of marriage (and divorce) counsellor to that King. Sarpi picked up the legacy of that earlier corruption of Henry VIII, but added his own sweeping revision in Venetian strategy.

13. On the effects on North America during this period, see H. Graham Lowry, *How the Nation Was Won*, Volume I (Washington, D.C.: Executive Intelligence Review, 1987). A politically hostile takeover of control of the leadership of my association, during my absence, in September 1990, led to the suppression of intention to print Lowry's second volume. Lowry, a professionally trained academic historian, had made what I had recognized, from the 1983 outset of the plan to prepare and publish the book, a crucially important major discovery of the way in which the seeds for the later Declaration of Independence were sown during the reign of England's Queen Anne. He was a true genius and patriot. The anti-American fascist international organization, involved in the indicated takeover, really hated Graham, and also American independence, for precisely this reason. When I returned to the leadership of my association, I was naturally determined to clean that mess out. That pro-fascist faction is, naturally, no longer represented in my association, but is overtly a part of my enemies, in the U.S.A. and abroad. Unfortunately, by the time I assumed leadership again, Graham was already suffering the illness which crippled him, and would lead to his untimely death; but, he maintained his clear head and brilliance to the end.

America's Untold Story

How the trans-Atlantic republican movement waged a continuous fight for freedom, beginning with John Winthrop's Massachusetts Bay Colony in 1630.

\$19.95

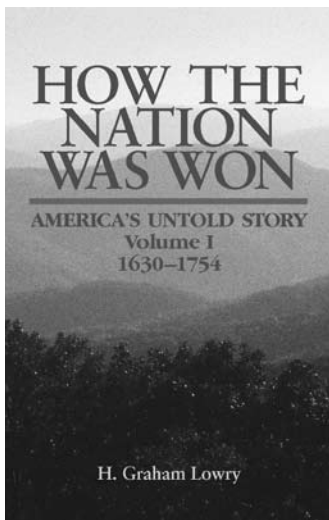

ORDER FROM
EIR News Service, Inc.
 P.O. Box 17390
 Washington, D.C.
 20041-0390

Order by phone, **1-800-278-3135**

OR order online at www.larouchepub.com

Shipping and handling: Add \$4 for the first book and \$1.00 for each additional book. Virginia residents add 4.5% sales tax. We accept MasterCard and Visa

1.20 Adam Smith's Ockhamite Hoax

Today's significance of Adam Smith as an economist, dates essentially from about 1763, when he came under the patronage of the British East India Company's notorious Lord Shelburne. He was of the same curious species as his contemporaries, David Hume, Hume's apostle Immanuel Kant,¹⁴ and the notorious hoaxster Sir John Robison. He is, of course, most notable for his tract denouncing U.S. Independence, the so-called *Wealth of Nations*, a book which, insofar as it treated the subject of political-economy itself, was largely a work plagiarizing the *Reflections* of the follower of the Physiocrat Dr. François Quesnay, A.R.J. Turgot. A better clinical insight into the origins of the troubled mind of Smith himself is to be found in his earlier (1759) publication, *The Theory of the Moral Sentiments*. It is fairly presumed from the systematic features of Smith's work, that it was this 1759 work which must have prompted Shelburne's inclination to employ Smith.

There, Smith refers to what he alleges are the uncertainties of any form of human knowledge. I excerpt some crucial parts of a passage from his 1759 book here. He wrote:

“... the care of the universal happiness of all rational and sensible beings, is the business of God and not of man. To man is allotted a much humbler [intention] ... the care of his own happiness, of that of his family, his friends, his country ... though ... we are endowed with a very strong desire of those ends ... it has been intrusted to the slow and uncertain determinations of our reason to find out the proper means of bringing them about. Nature has directed us to the greater part of these by original and immediate instincts. Hunger, thirst, the passion which unites the two sexes, the love of pleasure and the dread of pain, prompt us to apply those means for their own sakes, and *without any consideration of their tendency to those beneficent ends which the great Director of nature intended to produce by them.*” (Italics added)

Smith, writing there, is following, strictly, Sarpi's prescribed, systemically irrationalist, Ockhamite doctrine; but this is not peculiar to Smith alone. The same argument was to be made later, with slight alterations, by the British Foreign Office's Jeremy Bentham. The same kind of argument was made by all of the leading Haileybury School economists, including the Venetian Giammaria Ortes from whose 1790 English translation of his *Reflections on Population* plagiarist Thomas Malthus lifted his own 1798 *On Population*.¹⁵ The same essential argument for the same piece of witchcraft had been made earlier by Bernard Mandeville's *The Fable of the*

Bees, or Private Vices, Public Benefits (1734). The same systemic construction was proffered by the Physiocrat Dr. François Quesnay; Quesnay is followed in the dogma of the A.R.J. Turgot which was generously plagiarized by Smith.

All of these and related cases, are expressions of an intrinsically pro-oligarchical, and implicitly Delphic misconception of the nature of man and society. The Physiocrats Quesnay and Turgot expose this connection more clearly than their British co-thinkers, and are of special interest otherwise, because they express the empiricist view from the standpoint of emphasis on an attempt at portraying a raw physical economy from the vantage-point of a class of landed gentry. Quesnay's *Tableau Economique* is a crucial mapping of such presumed intellectual and physical connections.

This difference between Quesnay and his British co-thinkers is a consequence of the way in which the influence of René Descartes was spread from Venetian influence on the Netherlands to France and England.

1.21 Leibniz vs. Descartes

The center of the development of science in post-Westphalia Europe was the leadership of Cardinal Mazarin's associate Jean-Baptiste Colbert in developing the science-driven program of France. It was under the patronage of Colbert, that Gottfried Leibniz refined his work in science to such effects as are to be recognized from his unique originality in developing a calculus premised on the challenge which Kepler had bequeathed to “future mathematicians.”¹⁶ René Descartes was among the key figures developed by the Dutch Liberals as an instrument of Sarpian empiricism, to counter the development of science in the Colbertiste France of Pascal, Huyghens, and Leibniz.

In turn, it was Leibniz, beginning 1692, who began his exposure of the fraudulent character of Cartesianism in physical science, as the crucial point of this exposure was summed up afresh in Leibniz's 1695 “Specimen Dynamicum.”¹⁷

16. The root-origin of the Leibniz calculus is found, as I have emphasized here earlier, in the effects of Nicholas of Cusa's exposure of the fatal systemic blunder of Archimedes' quadrature of the circle. This discovery by Cusa emerged in the work of Kepler as the concept of the ontologically infinitesimal in the principle of gravitation associated with the definition of the generation of the Earth's orbit, as enriched by Kepler's generalized theory of gravitation for the Solar planetary system.

17. Probably the most convenient English translation of this for current English-speaking readers, is to be found in Leroy Loemker (editor), *Gottfried Wilhelm Leibniz: Philosophical Papers and Letters* (Dordrecht-Boston: Kluwer, 1989). Cf Leibniz's “Critical Thoughts on the General Part of the Principles of Descartes” (1692) and “Specimen Dynamicum” (1695). Here, in these locations, we encounter an immediate insight into the roots of both the catenary-cued discovery of the principle of universal physical least-action, a principle of dynamics, and the principal work of Bernhard Riemann on dynamics from 1854 on. This line of development is the proximate foundation of a physical science of economy. My own discoveries in the domain of physical economy, have been premised on this common feature of the relevant works of Leibniz and Riemann.

14. As in “I can't,” or “I cant.”

15. Curiously, but not really astonishing, the same Giammaria Ortes was treated favorably, if only in passing, by fervent anti-Malthusian Karl Marx.



Pieter Brueghel the Elder's "The Land of Cockaigne" (1567): a portrait of bucolic idiocy on the aristocratic estate so beloved of the physiocrats.

This was the same period of the writing of "Specimen Dynamicum" and of the opening of the collaboration of Leibniz and Jean Bernouilli in elaborating the catenary-cued principle of universal physical least action. This preceded the opening of Leibniz's role as a crucial political factor in the process, under England's Queen Anne, in the English succession to the institution of the British United Kingdom.¹⁸ During that same period, the preference of Leibniz's enemies, was to counterattack against Leibniz's powerful influence of that time by adopting the work of Descartes as the basis for an anti-Leibniz program in England itself. In light of the fact that the Netherlands-programmed Descartes retained nominally French attributes, it was deemed impracticable to import Cartesian ideology under an explicitly Cartesian label, into a France-hating England of that time. So, Hooke and other suitably skilled and witting followers of Galileo's hoaxes, were employed to synthesize a neo-Cartesian, anti-Leibniz cult in England, including a faked attribution of the invention of a calculus to an obscure academic figure known as a specialist in black magic dogma, Isaac Newton.¹⁹

18. Cf. Graham Lowry, op. cit.

19. John Maynard Keynes was entrusted with the duty of opening and examining that presumably hallowed chest of papers within which the alleged Newton discovery of a calculus was reputed to repose. At a public event at which Keynes was to report on the contents of that wonderful chest, he reported that there was little or nothing of scientific merit contained among these papers of Newton's, but, rather, odious relics of black magic redolent with the traditions of a Babylonian priesthood.

The most notable figure in the promotion of this creation of a synthetic, English-speaking "René Descartes" named Isaac Newton, was a Venetian, Abbé Antonio Conti, a devotee of the work of Descartes residing in Paris at that time. Conti would figure, until his death in 1749, as a key-stone figure in the organizing of a network of anti-Leibniz salons throughout much of Europe, a network which included figures such as D'Alembert, de Moivre, Voltaire, Maupertuis, Leonhard Euler, Lagrange, et al., whose systemically vicious errors were demolished in an exemplary way by Carl F. Gauss in 1799. Important Nineteenth-Century followers of the legacy of those salons included London-sponsored adherents to the Newton clique such as Laplace, Augustin Cauchy, and the so-called founders of "thermodynamics" Clausius, Grassmann, and Kelvin.²⁰ The concoction of the fraudulent "Second Law of Thermodynamics" was an outcome of this process.

This was the background for the emergence of a Quesnay associated with the premises of the Deer Park of France's King Louis XV's minority.

The most crucial, but not surprising feature of Quesnay's argument, is the clarity with which he echoes that social standpoint of the oligarchical Olympian Zeus to be seen in Aeschylus' *Prometheus Bound*.

For example, the working farmer of the feudal estate, is

20. The hoax of Clausius et al. was proffered by his circles as a fraudulent construction of Ecole Polytechnique scientist Sadi Carnot's 1824 *Reflections on the Motive Power of Fire*.

portrayed by Quesnay as distinguished very little from that estate's cattle. For Quesnay, the peasant, like cattle and field, must be maintained in their respective biological functions, but the profitable portion of the fruit of the feudal countryside estate is to be attributed to a magical, Aladdin's-lamp-like quality of the feudal landlord's title to that estate, not the productive mental activity of the peasant. The cow-like attributes which Quesnay assigns to the economic role and personalities of the farmer on the estate of the aristocratic landlord, unveil Quesnay as an adherent of the doctrine of the Olympian Zeus from Aeschylus' *Prometheus Bound*, which is also the dogma of the Giammaria Ortes plagiarized by Thomas Malthus's *On Population* and by the sponsors of the ultra-Malthusian "Global Warming" hoax of today.

Such doctrines as those of the aristocratic Physiocrats, are echoed in the social prejudices of the British aristocratic landlords, the baronial, knighted, squirearchy, and no-counts alike. This same Physiocratic-like, bucolic fantasy, passed over to be echoed in the notorious sentimentalities of the "robber barons" of our Nineteenth-Century U.S. manufacturing, and the predatory freebooters of the hedge-fund banditry today.

The social-economic implications of Quesnay's argument, are to be viewed more precisely from the vantage-point of a reading of the pseudo-scientific Descartes, and of the roster of neo-Cartesian Leibniz-haters refuted in Carl F. Gauss's original systematic denunciation of their common error, in Gauss's 1799 doctoral dissertation.²¹ That set of sundry quacks, such as Maupertuis, and renegades from science, such as Leonhard Euler, composed the anti-Leibniz faction of de Moivre, D'Alembert, Euler, Lagrange, et al., and of some British political-economists associated with the dogma of the British East India Company's Haileybury School.

The common ideological feature shared by the followers of Euler et al. and Locke, Mandeville, Smith, et al., has been a crucial factor of corruption in bringing about the ruin of the U.S. economy over the recent forty-odd years. That is to say, in the subject at hand, as in other, comparable areas of concern,

1.22 *The Outcome of Haileybury*

To gain a competent view of modern economic doctrine and practice, the British school's famous Mandeville, Quesnay, Adam Smith, David Ricardo, and Karl Marx must also be recognized as essentially victims: a type of ideologues polluting the field of economics, who suffered from the same, misguided, general epistemological follies common to all varieties represented by the Haileybury School. Thus, after Quesnay, in later versions of the physiocratic ideology, the source of the fruitfulness is said to be the magical properties of the land-area itself, or, simply the "mystery of the marketplace," thus copying, but also superseding the ideology previ-

21. A subject to which Gauss turned at a later time under the heading of the "Fundamental Theorem of Algebra."

ously expressed by belief in the allegedly magical work of the rural landlord's aristocratic title.²²

However, to understand how this corrupt influence, radiated from the British school, works within the processes of the mind of its duped victim, we must understand the equivalence of what I have referenced here as a corruption of mathematical physics in the decadent phase of Leonhard Euler's intellectual life, the equivalence to the ideology expressed by the British schools of intrinsically imperialist political-economy.

There is no actually scientific aspect to the kind of statistical and related economic dogma currently associated with the government and, also, the usual university classroom, in the U.S.A. today. In the field of what is called "economics," our nation's official economic, and related life, has been taken over almost entirely by virtual ouija-boards. Our national economic and related policy has been controlled by forms of wild-eyed, abacadabrist varieties of statistical superstitions; this has been the usual state of affairs in most important circumstances, since that period of transition from economic power to virtual bankruptcy, which was unleashed in the wake of the rampage of the "68ers," under the successive, 1969-1981 Nixon, Ford, and Carter administrations, and, more notably, the ruin unleashed as a frenzy by the Trilateral Commission, to bring us the decades-long, ruinous reigns of Federal Reserve Chairmen Volcker and Greenspan.²³

From the outset, in a comparison of Euler's attack on Leibniz with the essential incompetence of the British school of political-economy, what should soon command the stu-

22. In U.S. history, this figured in the break by Thomas Jefferson from the U.S. Federal Administration of President George Washington and his Treasury Secretary Alexander Hamilton. Jefferson was clearly wrong, then, and in the issues of the Presidential election of 1800, on the particular issue of Hamilton's famous report to the U.S. Congress *On the Subject of Manufactures*. However, in light of the famous Panic of 1837, the attempt to associate Jefferson with the anti-National Bank policies specific to former Aaron Burr accomplice Andrew Jackson and President Jackson's swindling patron Martin van Buren, is a stretch far too far for a scrupulous conscience to bear today. Jefferson's several mistakes in policy are notable, but he was no scoundrel, and therefore is not justly linked with such authors of the 1837 Land Bank Panic as Presidents Jackson and van Buren. Hence, the crucial distinction of Franklin Roosevelt Democrat from the Jackson tradition. FDR moved the Democratic Party of 1932-1933 to fill the moral vacuum of leadership left in the wake of the corrupt and ruinous policies of the Coolidge and Hoover administrations. Cf. Anton Chaitkin, *Treason in America*, 2nd Edition (New York: New Benjamin Franklin House, 1984, 1985).

23. Volcker, as Chairman, can be assessed in retrospect today as what he pretended to be. His successor's, Greenspan's, conduct, can be viewed now as having been frankly sheer monetarist lunacy run amok. It must be conceded, nonetheless, that if there was madness in old Ayn Rand fanatic Greenspan, it was the madness of the method which was implicit in the role he was transfigured to play in the assignment extended to him by the disastrous, 1929-style crisis of October 1987. The result might be compared by some with the case of the fundamentalist preacher who, discovering he had acquired gonorrhea, sought to escape from the risk of being singled out, by spreading the condition as widely as possible.

dent's attention, is the fact that *no actual, efficient form of universal physical principle is permitted within either of those two sets of assumptions*. The key to this point is found, typically, in that moral bankruptcy expressed by science-apostate Euler's 1761 *Letters to a German Princess*, where he elaborates the same conceptual argument, there in relatively simplistic terms. That is the corruption which underlies his role in counterfeiting a Fundamental Principle of Algebra. Gauss's 1799 attack on the fallacy of the work of Euler et al., is exemplary.

This fraud by Euler is to be seen as typical of him, when one has recognized that he had been, formerly, an admirer of Leibniz and also a pupil of Jean Bernouilli. It was Euler's own personal corruption which had carried him over into the company of the faction of the followers of Sarpi, Galileo, Hobbes, Descartes, Locke, and those salons associated with the Paris-based Venetian, Abbé Antonio Conti, and Voltaire. From the standpoint of epistemology generally, and theology in particular, Euler had passed over into Sarpi's diabolical school, the school of what Stephen Vincent Benet's story, *The Devil and Daniel Webster*, labels "Old Scratch," or the Mephistopheles of Kit Marlowe's *Dr. Faustus* and Goethe's *Faust*. To make the same essential point in other words, Euler had gone over to that worship of the wittingly diabolical Ockhamite irrationalism of Sarpi which Euler himself had expressed in his morally and scientifically disgusting 1761 "science for ladies"-style of his *Letters to a German Princess*.

For such apostates as those, there is no actual universal physical principle afoot in the universe, and, therefore, no immortal human soul. There is, as Quesnay insists in his own choice of fashion, no essential, functional or moral difference between a peasant on the landlord's estate, and a cow. In other words, the common features which I have touched upon in this immediate part of my presentation, are an expression of the same principle of a soulless oligarchical system typified by the reign of the Olympian Zeus which Aeschylus depicts in his Prometheus Trilogy.

This is the keystone-issue of the actual physical science of political economy implicit in the work of U.S. Treasury Secretary Alexander Hamilton.

I shall identify the relevant connections here, leaving the development of the issues of a general economic science to the following chapter of this report.

1.23 Man or Ape?

To make the essential point in a way which is the simplest available argument, but nonetheless honest, we must say that the essential difference between man and beast, as between man and ape, is that all lower forms of life, lower than man, are decently considered, in first approximation, as subjects of ecology. Humans' behavior, unless they are being very stupid, is not. "Human ecology" is not a religion of the monkeys, but of people try to make monkeys of themselves, and also others.

(Worse are the religious followers of John von Neumann, who share the radical positivists' delusion, that the human intellect could be replicated, even surpassed, by digital computer technology.)

As the work of Academician V.I. Vernadsky, especially during the last decade of his life, has greatly enhanced our insight into such matters, the known universe of physical science establishes that universe as Riemannian in principle, and asserts the known universe as a whole, functionally, among three interdependent *phase-spaces*: non-living, living processes, and the developable, creative powers unique to the individual member of the human species.²⁴

The exemplary difference between man and ape on this account, is that shown by the effect of mankind's discovery and use of a universal physical principle, or the like. These discoveries either express, or reflect those sovereign qualities of the human mind which are most readily identified as the discovery of an experimentally valid universal physical principle, or a comparable principle of Classical forms of artistic composition.

The related evidence is that the "Second Law of Thermodynamics," if applied as a general principle (rather than a case of a special, limited type of phase-space), is so absurd as to be generally considered, in the case of representatives of modern cultures, as grossly stupid, or even as, functionally, among clinically insane opinions. The effects of the general acceptance of that sort of mental disorder in opinion, are demonstrated to have been extremely destructive in their effects on modern civilization.

The generation and employment of knowledge of those universal principles of a Riemannian type associated with, for example, Vernadsky and the matured Einstein, mark the individual, when treated either as an individual, or a representative of a cultural practice of such individuals, as a "Promethean fire-bringer," in the sense of the definition of the existence of man and woman in *Genesis* 1. It is this quality which competent theologians would recognize as the expression of that human soul, whose existence marks the essential distinction, in both existence and function, of man from beast. *People who are actually human, do not eat people*.

The proper definition of political freedom, as such a notion coheres with the intent of the Leibnizian principle of "the pursuit of happiness" in the U.S. Declaration of Independence, or the Preamble of the U.S. Federal Constitution, is the exercise of those creative mental powers associated with valid physical scientific discovery and the comparable faculty of Classical artistic composition. The proper concept of Freedom as a state of being, is exemplified as freedom from reign over society of the deeply corrupting influence of the implicitly Olympian practice of the Physiocrat or his likeness.

24. Cf. Lyndon H. LaRouche, Jr., "Vernadsky & Dirichlet's Principle," *EIR*, June 3, 2005.

In modern European culture, this quality of freedom is expressed, variously, both as political, and as physical-scientific in the sense of Cusa and his followers such as Kepler, and artistic in the sense of Leonardo da Vinci, Raphael Sanzio, Rembrandt, Shakespeare, J.S. Bach, Mozart, Beethoven, and Schiller. The objective of the true republic based on such intentions, is to develop each among all newborn infants into a race of poets, scientific discoverers, and statesmen, and to discover some means to extend this role to individuals whose relevant potentials of that sort are biologically or otherwise impaired. It is the right to have a sense of participating in the past, present, and future of society, in that sense of mode, which defines the condition for the kind of quality of *happiness* which Leibniz prescribes as the alternative to the depravity of a society molded according to the pro-slavery dogma of Locke. It is the conditions for individual and general happiness, so defined, which must be the fundamental law of organization of society.

This has not yet been achieved, but, so what? The essence of a journey is the process of getting to some destination. We live in that journey which our progeny will perpetuate.

When all of those considerations I have just identified, and others of similar import, are taken into account, the essential principle of relevant kinds of forward motion in society's progress, is not located in the arrival at some final destination, but in the process of getting to a valid, more advanced level of universal achievement of mankind than before. "Getting there" signifies the discovery of those validatable principles whose acts of discovery and expression, identify the quality of the motion which corresponds to the intended arrival at a limitless destination. Contrary to ideologies such as those of Clausius and Grassmann, the goal of the continued development of our universe is never a finished work; it is *anti-entropic*, and, therefore, mankind's work will never cease to lie before it. In the words of Cotton Mather and Benjamin Franklin, the purpose of our individual existence is to do good. This is Leibniz's best of all possible universes. Our present is, therefore, properly apprehended, as by the best theologians, as it were a simultaneity of eternity.

In our U.S. history, during the Nineteenth Century, a great effort was expended by our republic's British and other adversaries, domestic and abroad alike, to degrade the image of the chief architect of our republic from among us, Benjamin Franklin. Special societies and other projects were promoted

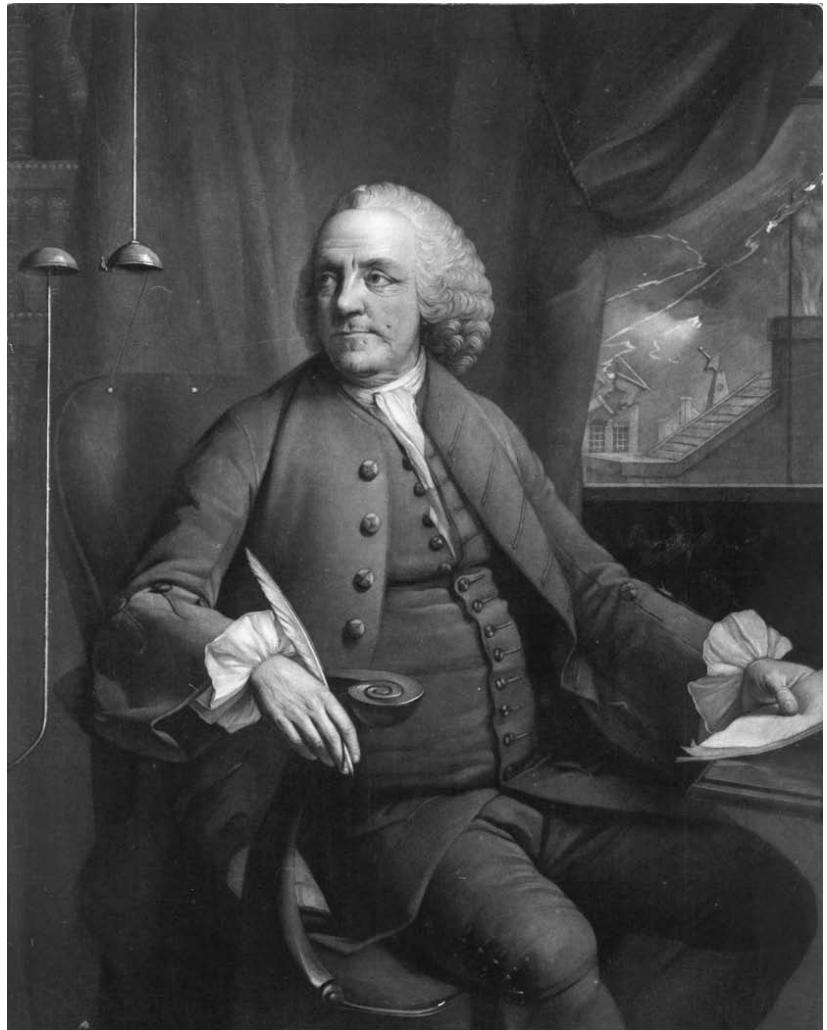

Library of Congress

Benjamin Franklin, looking at electrostatic bells. Known as Franklin's bells, he installed them to warn him of approaching thunderstorms. Visible through the window is lightning striking a building. A scientist—not a tinkerer!

among us to the effect of degrading the image of one of the great scientific leaders of the Eighteenth Century, among the promoters of the development of chemistry, and the virtual discoverer of electricity, the Franklin heralded as a Prometheus among the best spirits of Europe in his time, into the likeness of a mere tinkerer.

The principal evil of all known societies up to the present time, has been the systemic division between a ruling stratum which reigns over the larger portion of their own and other nations as if that larger portion must be penned up within the status of virtual human cattle. Hence, the proper image of a Satanic principle, is that which coincides with the figures of the Olympian Zeus of Aeschylus' *Prometheus Bound*, and with the image of a reigning culture based on the bi-polarity of the satanic figures, Apollo and Dionysos, of the cult of Delphi.

2. Physical Economy as Dynamics

As the cited, tragic, 1998 case of the LTCM's Myron Scholes et al. illuminates a crucial point, the common leading cause of economic tragedies of contemporary statecraft in the large, falls within the class of remedies supplied as a relatively sophisticated aspect of scientific method which I have already referred to as "dynamics." In social-economic processes as such, this technical term's applications are commonly met in two distinct expressions, both as *dynamics*, as that term is applicable to both the domain of physical science as such, and to encounters with systemic forms of social processes. The presently, extremely menacing effects to be addressed by both uses of that term, in both physical processes and also social processes, are illustrated in a currently most relevant fashion, by an onrushing, particular economic and social calamity striking an area within somewhat more than a sixty-mile radius of our nation's capital.

First, I develop the leading points to be made in viewing that case, and then locate the root of the matter within the respective domains of individual and mass social behavior.

The way in which the U.S.A. or Europe, and other places, have used the private automobile, or truck, especially since the aftermath of World War II, is typical of the failure of a society to grasp the extremely practical implication of failing to examine policies of practice as I do here. These errors in practice must be viewed, now, from the standpoint of certain types of non-statistical, but nonetheless functionally coherent, and scientifically necessary attention to patterns in individual, or otherwise localized choices.

I use that case here as an illustration of the crucially important role of Gottfried Leibniz's notion of *dynamics*, as I have already indicated its application to the shaping of the work of physical science. I now extend the view of that matter to include the domain of mass social behavior, *the domain of the U.S. shaping of its public policy to the effect of producing certain among the kinds of effects to which I now turn your attention*. As an example of that effect, I am comparing the way in which the current use of the private automobile, when used as a primary mode of daily commuting to and from place of employment, has contributed to destroying the economies of the U.S.A. and also Germany, among many others.

The first point of illustration of that point to be considered here, is continued resistance to the present option of replacing the combustion of petroleum products, as automotive fuels, by hydrogen-based fuels produced locally by high-energy-flux-density nuclear-fission reactors. The types of reactors desired for this application are becoming available, belatedly, today. This was a policy which came up as one among a variety of science-driver conceptions considered by us, during the course of a long evening's discussion of future science policy for the U.S.A., held between me and the late Professor Robert Moon, in Chicago, back during the 1970s. An associate of mine was present during the discussion, but he was chiefly

In other words, to quote the great conductor Wilhelm Furtwängler, good music must be that, as J.S. Bach's method of composing fugues requires, composed, conducted, and performed "between the notes." In other words, this means the principle of *the functional infinitesimal* of physical science which is also central to Classical music and poetry, as specified, in contrast to the crucial error of Archimedes, by Nicholas of Cusa, Kepler, Leibniz, Riemann, and other notables.²⁵

The hellish folly of the notorious Myron Scholes' methods of financial forecasting, is perversely useful only insofar as its folly is examined as an illustration of the crucial point being made here, at this juncture, the same folly which an intellectually decadent Leonhard Euler perpetrated in his infamous *Letters to a German Princess*. This is the same piece of anti-scientific stupidity expressed by Abraham de Moivre, D'Alembert, and Lagrange, and, also, later, Laplace, Cauchy, Clausius, Grassmann, et al. on the subject of the physical actuality of the infinitesimal, as the elliptical expression of the infinitesimal was defined by Kepler for gravitation, and elaborated by Leibniz in Leibniz's uniquely original discovery of the calculus, and in Leibniz's development of the catenary-cued concept of universal physical least-action. Where Kepler, Leibniz, and Euler's teacher Jean Bernouilli had followed Cusa's exposure of the systemic blunder of Archimedes on quadrature, in defining the notion of the infinitesimal as an expression of the existence of universal physical principles of action, de Moivre, D'Alembert, Euler, and their accomplices degraded the notion, into a merely imaginary beast existing, allegedly, only as ghosts haunting the depths, as imagined to inhabit the merely algebraic viewing of the domains of cubic and biquadratic functions.²⁶

These considerations lead us to the most crucially important aspect of economics as science, the subject of *dynamics*, as that term was taken by Leibniz from the Classical Greek *dynamis* of the Pythagorean scientists and the usage of Plato and his Academy, and presented in his "Specimen Dynamicum."

25. This was the discovery of the infinitesimal by Cusa and his followers.

26. The correct view of the infinitesimal as an expression of physical action, rather than of mere algebra, was already developed by the Pythagoreans, as this is illustrated by Archytas' construction of the doubling of the cube, and the related issues of cubic and biquadratic physical, rather than merely algebraic functions. The silly view by Euler et al. is a reflection of what he himself presents repeatedly as simple aprioristic reductionism, such as that of an algebraic method premised on the aprioristic follies of Euclidean geometry. The resort to apriorism by Euler et al., must be regarded as more in the character of the bad theology of the Delphic worship of the satanic Olympian Zeus, than any actually scientific concern. Although some readers might protest that such scientific matters are not appropriate features of constitutional law, they err. It is the denial of the implications of the infinitesimal which is the root of the habit of treating human beings as if they were merely cattle.

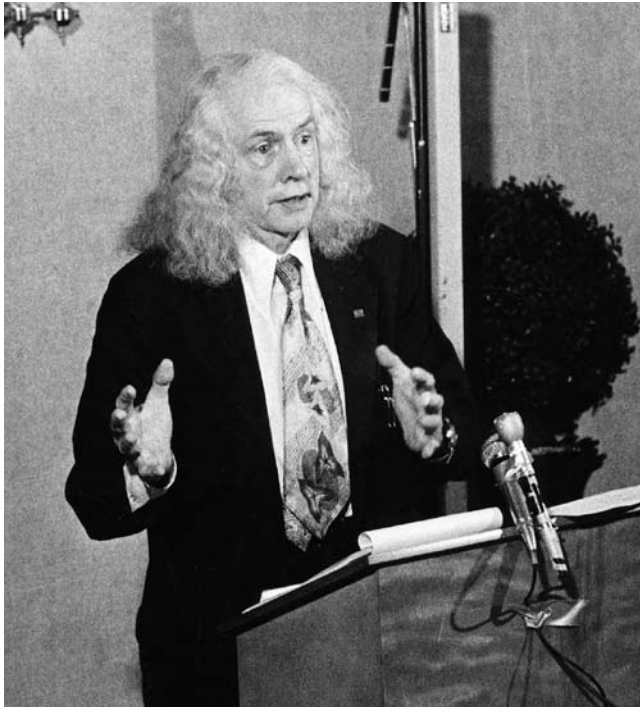

EIRNS

Dr. Robert Moon speaks at the founding conference of the Fusion Energy Foundation, Nov. 23, 1974, in New York City. Until Moon's death in 1989, he and LaRouche discussed a variety of science-driver approaches to boosting the economy, as well as controversies in nuclear physics.

content to let the discussion between me and Professor Moon rip through the passing hours of that exchange.²⁷

First of all, the continued practice of reliance on the hauling of intrinsically cheap (per ton) hydrocarbon fuels thousands of miles around the Earth, is, in several ways, both an unnecessarily costly business, in addition to being a part of a nasty operation against the world by certain monopolistic oligarchical interests of the type which might be rightly considered as of the variety of up-to-no-good, monopolistical powers. Today, in light of the immediate prospect of nuclear modes of producing a superior quality of combustible fuels, it were better to employ hydrocarbon stocks as raw materials of manufacturing performed in the vicinity of the place where the

27. Professor Moon's academic and related career had been launched in his development under Chicago University's internationally celebrated physical chemist Professor William Draper Harkins, which led, in time, to Professor Moon's notable supporting role, under Fermi, in the development of the design for nuclear-fission reactors. He and I became associated in the course of the founding of what became the Fusion Energy Foundation. The principled controversies within nuclear physics in which Harkins and Moon were engaged, respectively, are of leading world importance still today. Through my own role in the Fusion Energy Foundation, I was fortunate to be an onlooker in some of this, and to be able to continue to push the continuation of Moon's richly promising, but still uncompleted work in this matter to the present day.

extraction occurs, simply on the basis of the fact, that the greater the physical value of a ton of freight hauled, the lower the percentile of cost of transport of the material hauled.

There is a large factor of cost-saving in such a proposed change in policy of practice. The idea of relying on extraction of raw materials, by drawing down of ore-stocks which were created by the biosphere, as deposits, over a past many millions of years or more, has a long-term negative impact on the future of our planet. The future of mankind should be considered as requiring the regeneration of kindred classes of "raw materials," and also the generation, synthetically, of new classes of materials yet to be defined and designed.

This, however, is not the only factor which should be considered as impelling prudent societies of today into reliance on synthetic fuels which are to be produced by aid of nuclear-fission and comparably technologically advanced processes. The physical-cost efficiency of production is increased by such a change in policy, increased per unit of society's consumption of total product. This benefit is obtained by upshifting the technology of production, by emphasis on sources of power applicable to qualitatively higher "energy-flux-density" of heat-action per square-centimeter of cross-section of power flow.²⁸

For example, only scientifically illiterate, and reckless "bio-fools," could propose a shift to the use of so-called "bio-fuels" today. When a society takes a highly organized form of product, such as the product of living processes, and consumes it, on a large scale, as an inorganic form of fuel, we are, relatively speaking, lowering the quality of support for human life, as measurable per capita and per square kilometer, on our planet. In earlier times, when we knew no better, and the population density of our planet was far less, the use of what might be termed biofuels, such as the practice of mere burning of wood and coal, although practices which have been wasteful in the long run, could be considered as relatively tolerable, even indispensable at that time, because desirable technological alternatives were not yet available for use. Now, growth of the world's population, and the availability of certain relatively advanced science and technology make commitment to rapid introduction of higher technologies, such as nuclear fission and thermonuclear fusion, globally, both physically and morally imperative.

The point to be emphasized is, that power is not to be measured, as science-illiterates do, in raw calories, but in the *quality* of heat-action, which is properly measured as increasing the heat-intensity measured in units of cross-section, which might be usefully named Vernadsky units, of relatively negentropic flow: as per-square-centimeter cross-section of the energetic process itself. On this account, a calorie of power in the form of a living process, or a product of a living process, is implicitly a more useful *quality* than its consumption as a

28. From here on, in this report, it is assumed that the notion of "power" used by me, is of the order of anti-entropic upshift, not simply caloric.

FIGURE 3
Fuel and Energy Comparison

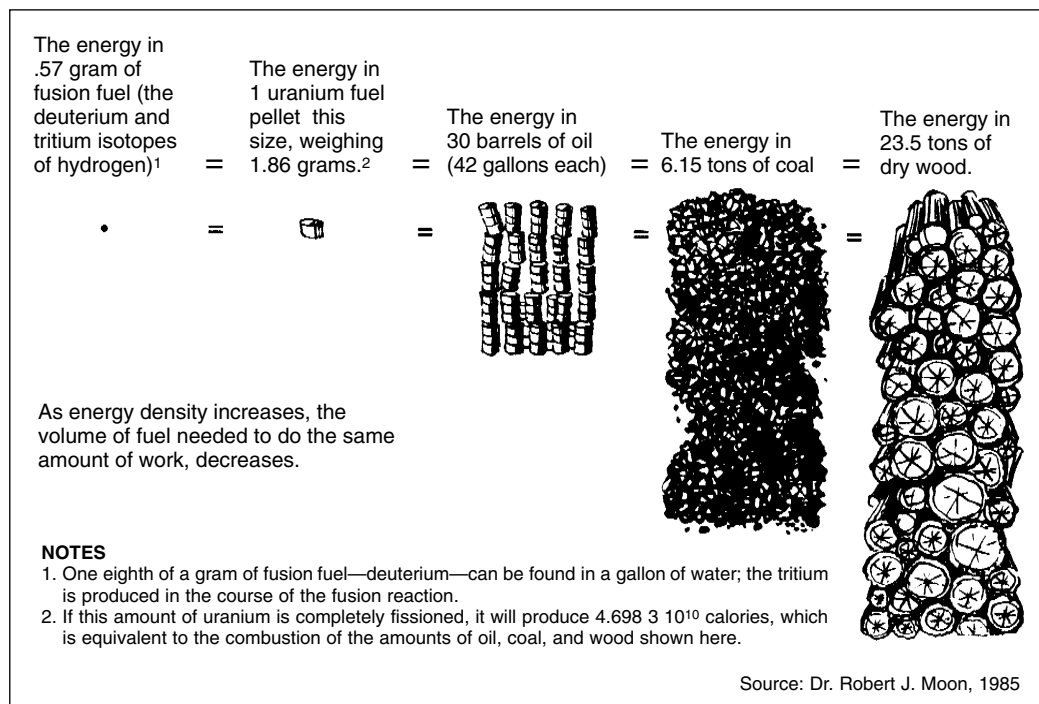

mass of the planet otherwise, is superseded by the increase of the mass effects of the Noösphere relative to the Biosphere.

Thus, if we recommend consumption of biofuels today, we are tending to lower the quality of the human environment, and thus tending to raise the relative mean temperature of the planet, by a shift from a useful form of highly organized, living processes, to use of these products, and their associated processes, in ways which lower the quality of the environment which supports life, including human life, on Earth.

raw material to power an action of so-called “softer,” lower energy-flux-density.

For example, the quality of human life on Earth depends upon a process of photosynthesis, which produces plant-life such as grasses and trees. While sunlight is generated in the Sun by high energy-flux-density processes, by the time it reaches the lower atmosphere of our Earth, it is of relatively very low energy-flux-density. The best ordinary use of sunlight impinging on the surface of the Earth, is typified by the action of a sophisticated process known as the action of chlorophyll. The action of chlorophyll, which grows plants of various types, lowers the temperature of the atmosphere, and makes areas of our planet habitable; this is an action of higher relative energy flux-density, an *anti-entropic upshift*, than the spillover from Solar radiation which it has captured. Thus, up to a certain point today, a marginal increase in the carbon dioxide content of the atmosphere would encourage plant growth, and thus cool the environment. It is the means to make the desert bloom, and to maintain a livable quality of weather for human beings.

Similarly, the creative potential inherent as within individual human beings, who consume foodstuffs supplied by lower forms of life, has a more powerful effect in the application of valid discoveries of physical principle to the planet as a whole (i.e., the Noösphere), than the material (from the Biosphere) which was consumed as food.

Similarly, the increase of the mass of the Biosphere, with its included, peculiar fossil residues, relative to the abiotic

This political-ideological, pro-malthusian tendency toward dependency upon biofuels, is already exhibiting its characteristics as policy, as a way of thinking which must result in early outbreak of a human demographic, and therefore moral disaster for all nations and peoples of the planet.

Admittedly, unfortunately, today, there is still what is termed a “consensus” to the contrary among many economics illiterates, including elected officials of our legislatures, and other dupes, who do not yet understand the elementary principles involved here; but, that is no excuse for transforming ignorance into the adoption of a policy based upon cruel expressions of avoidable stupidity. The remedy for that ignorance of the relevant illiterates would not be biofuels, but better schools.

Compare the energy-flux-density of various choices of fuels, comparing the relative availability of more efficient choices of sources of generation and transmission of sources of power as society has progressed technologically. Add to this, the fact, that of all technologies, poverty, ignorance, and superstition, are the most deadly, and the combined action of the three, is the aqua-regia of social-political technological follies.

That said on the indispensable elements of scientific background, return attention now to the subsumed matter of the particular folly of the way in which misuse of the automobile and truck has been promoted to the effect of ruining both the relative prosperity of our people and wrecking the performance of the economy itself.



EIRNS/Chris Jadtz

Against the background of what I have just stated here, look at the degeneration of the entire region around the nation's capital, Washington, D.C., or New York City, since the birth of Levittown on Long Island, and in the bedroom areas from around the nation's capital since, notably, as recently as the post-Carter Presidency, early 1980s. Contrast what is termed, euphemistically, this "development" which has been driven chiefly by the crudest and most reckless impulses of predatory greed, to the preferable sort of planning of development which I have just summarized above. Economically, the net result of recent decades' post-industrial society trends, can be fairly described as, speaking economically, clinically insane, in respect to their effects. One might hope that the persons engaged in employment in the sundry functions of government in and around our nation's capital, might have noticed the ominous trend toward a national catastrophe in this pattern of the recent quarter-

century and longer.

Currently, the inner part of the indicated area including and adjoining the nation's capital, is the engine of employment for households as far distant as two hours or more of driving time, with soaring prices of highway tolls, each way, from locations as distant as West Virginia. Meanwhile, as the economy of surrounding states, such as Michigan, Indiana, Ohio, and Pennsylvania collapses, there is migration into housing within a radius of about two hours' driving time, to and fro, from Washington, D.C. The gain which this population-shift brings to the greater D.C. area, has had a very dark side, a dark side which is becoming an obvious economic and social disaster at the present time, as the margin of a resident's financial equity in housing is now collapsing, even into purely negative valuations, at an accelerating rate.

To facilitate the referenced, insane abuse of land-area during recent decades, it had been found desirable to develop broad arteries, such as multi-lane toll roads, to funnel the flow of daily blobs of traffic-jam between the outskirts and center of this daily traffic-pattern. At the same time, as Loudoun County is a prime example of this, the process of so-called "real-estate development," causes the burgeoning of overstuffed, poorly organized (functionally) residential communities, and often also overflowing cesspools, in communities whose only significant revenue of local government is the tax revenues gleaned chiefly, directly, or indirectly, from household incomes of commuters. All of which is describable in the kindest terms available, as really very, very stupid practice.

Meanwhile, the soaring price of real estate, and therefore of rentals, too, fosters the potential for crime in the form of activities associated with drug-trafficking, festering concentrations of all forms of organized and related criminality, which must be constantly rooted out by vigilant law-enforcement intelligence work, and by related efforts. As the recent trend toward a general economic collapse has now intersect-

The Tragedy of the Commuters

Consider, for example, the ruinous effects of the post-World War II de-industrialization of both New York City and the adjoining region of northern New Jersey.

In the desirable organization of productive life, a finite and well-bounded urban area is situated within a surrounding area with characteristics such as forests and agriculture. Prudence places particular emphasis on production of agricultural products of the type consumed in the nearby urban center. The urban area and its immediately adjoining region, contain relevant manufacturing and comparable places of employment, to the effect that the urban locality and its adjoining industrial or related development, provide a relevant choice of principal types of places of employment for the inhabitants of the urban region.

Typically, in happier cases of development, the adult inhabitant can usually walk to place of work, or reach those premises, preferably by public transit facilities, within about a quarter of an hour. The wisely crafted suburban area is also a significant source of agricultural and other goods consumed within the urban area, and is also often itself a market for the products of urban industry and scientific-technological services.

This approach to regional planning of land-area and related development, including zoning, corresponds to lessons from our national experience since approximately 1620, and also that of much of the history of Europe, in the facilitating of the conditions for the development of modern life of nations and their component regions as a whole.²⁹

29. The case of the wines and cheeses available within France as its produce, is an expression of the heritage of Charlemagne and of Louis XI. Similarly, the development of the inland waterway systems of France and central Europe reflect the policies of Charlemagne, and projects specified under him which have been in use or have appeared as a continuation of his administration's policies on this account, up to current times.

Degeneration of the Region Around the Nation's Capital



EIRNS/Stuart Lewis

Foreclosures in upscale Loudoun County, Va., which LaRouche has called “ground zero” for the real-estate implosion.



Gang graffiti in a tunnel in Leesburg, Va. Crime is on the rise throughout the D.C. suburbs.



EIRNS/Stuart Lewis

The Greenway, a private toll road in Northern Virginia, has residents up in arms at the toll for a 13-mile drive or less. The owners are seeking to raise it to \$4.80.



EIRNS/Philip Ulanowsky

Route 267 in Fairfax County, Va., during the morning rush hour. The region's highways have become a vast parking lot at peak times of day.



EIRNS/Stuart Lewis

A familiar scene in the greater Washington area, as every acre of land is crammed with new housing, constructed for the bubble.

ed what had been recently soaring real-estate prices, the relevant communities are now sitting on a certain kind of economic time-bomb. The implosion to be expected arrives, when what had been heralded euphorically as Loudoun County real-estate “development,” back during the 1980s, will now turn very ugly, as the sources of revenue collapse, and the county government is left to suffocate in the combined effect of inescapable masses of local governments’ obligations incurred by the “growth,” a crisis which is already erupting now, as the available sources of tax-revenues have collapsed.

I have warned that Loudoun’s real-estate bubble has become a leading candidate for the potential role of “ground zero” for what is to be expected, under current habits of practice, as the great real-estate-mortgage implosion of this presently waning decade. Since I first made that warning, the un-

folding pattern has been precisely what I had foretold. Unfortunately, in these times, our abundant, perennial Micawbers do not seem to accept a well-founded, but personally inconvenient warning, until after the relevant disaster has already happened—then, they scream and howl!

The proximate source of this lurking real-estate “development” catastrophe, has been the reckless show of sheer incompetence, or perhaps much worse, by the so-called “real-estate development” operations. In this case, we have a prime example of exactly how *not* to use and develop land-areas. The disease is not limited to the greater Washington, D.C. region; the effects are also the disasters, of a different form, transported, as grim effects, to the relatively depleted states such as Pennsylvania and beyond.

This is what the disease known euphemistically as “The Trilateral Commission” policies of the 1970s, has done, as the

economic equivalent of perpetual rape, to this affected region around the nation's capital, and also to the larger regions, into the Appalachians and beyond.

Beyond the present moment's time and space, there is the ominous time ahead, when the matter of the quality of the construction of structures built during the recent quarter-century, expresses itself as the condition of decayed premises whose relative value has collapsed to a fraction of its nominal mortgage-value. The threatened condition now is far worse than what I witnessed in relevant parts of New England, during the early 1930s effects of the economic depression caused by the policies of the Coolidge and Hoover (and also Andrew Mellon) administrations.

That illustrates the situation at hand. Now, explore the interrelated, respective social and physical-economic dynamics.

2.10 The Highwaymen

That said, focus upon a crucial element in this massed traffic in economic insanity, the traffic of the commuter's automobile and its favorite prostitute, the highway system which gorges itself with the usurious proceeds of the combination of commuter traffic and real-estate "development."

About two hours each way, five days a week, is the equivalent of about two to three work-days taken out of the life of the commuter each week. This does not include the driver's incurred costs for use of the automobile, including tolls, during that time. Compare these costs with about a half-hour a day, to and from "the job," in a well-organized community.

For a moment, put aside the folly of the way in which the habitation and work within the commuting radius of the greater D.C. area is presently organized, both as habitation and work-place. Look at the commuter's automobile. Why is there not a magnetic-levitation system which could transport commuters from as far as West Virginia at lapsed-times of little more than a quarter hour? Or from a reindustrialized Baltimore seaport-area to Pittsburgh? Or, from Bangor, Maine, perhaps with a diplomatic stop at Kennebunkport, down through Boston, running across the notorious site of the old railway bridge at Bridgeport, through New York City, Philadelphia, Baltimore, Washington, to Atlanta? Open up high-speed passenger and freight routes cross-country to the Pacific, northward and southward. End the insanity launched with the signaled collapse of the New York Central and Pennsylvania railroads at the close of the 1950s, and return our nation to the prosperity it had achieved through policies

The first commercial run of the maglev train from Shanghai to its airport, on Dec. 31, 2002, achieved a speed of 430 kilometers per hour (267 mph).



Transrapid

cohering with the nation-building conceptions developed under Secretary of State John Quincy Adams. Three hundred miles an hour by land-routes, using magnetic levitation technology, is now an established policy of practice. It is not merely a better option; it is an urgently needed revolution in world economy.

Look, again, at the Loudoun County problem from this point of reference. The point is not simply a matter of having modern forms of high-speed commuter-systems; it is primarily a matter of the way in which entire land-areas should be organized, in a relatively decentralized way. This means a nation as a centralized system of decentralized regions, a nation organized economically in a way which corresponds to the Federal autonomies of its component Federal states, a way which permits a greatly reduced requirement for the ration of individuals' living-time organized around daily, tedious, and costly commuting. Do not think in terms of the economy of a commuter transit system competing with commuters' automobiles; think of a commuter system's "market" in terms of a greatly reduced number of commuter *automobiles'* miles (and hours of a lifetime) wasted on highway systems. Think of the kinds of policies of land-management of work and habitation, which, according to the supreme constitutional law of our Constitution's Preamble, make life better for our population and their posterity, and prompt the admiration, and, hopefully, the cooperation of foreign powers.

Add in another very important consideration: big trucks, where mass-transit of freight should operate by more economical and efficient means, instead.³⁰

Consider the relevant fact, that I spent part of my life in Lynn, Massachusetts, then a city of about 100,000 population; my walk to, and from high school required about a quarter of hour, to, or from the public library in the center of the city, a half an hour; commuting in either direction to, or from Boston later, under favorable conditions, about a half an hour. Or, within Boston, I frequently walked a distance of about two miles, or more. Later, in New York City, I often walked the distance from my office on the east side of 42nd Street, to my West Side residence near 96th Street. In the meantime, in late adolescence, I had often walked the distance, often both ways, between my residence in East Lynn and a job in the nearby city of Peabody. Walking like that, *Andante*,³¹ gave me the opportunity to think about serious subject-matters, and I was very serious in intellectual matters in those times.

There is no doubt that these habits expressed during my youth in Massachusetts, and my young manhood in Manhattan, contributed to the relative state of health I came to enjoy in later years. Although I tended to walk more than my typical peers, my habits were not atypical of my generation. Those walks by me were relatively long, because they gave me the opportunity to think, away from distracting circumstances, which is something which I preferred very much, when the occasion permitted. For me, as a representative of my generation, the increasingly injurious effects in the changes of organization of daily life from those past times, to present conditions, are more clearly sensed and known than among most persons of younger generations. Nonetheless, that difference in shading of life's experience is part of my advantage in authority, in presenting the ruinous changes which our nation has suffered during the course of developments since 1945-1946.

There is another, cultural aspect to that bit of my personal history. Any economist worth his proverbial salt lives out what he is thinking about when assessing the kind of experience he or she has occasion to assess, the effect of the process being described on relevant cases of actual other persons' settings. *Put yourself in the other fellow's shoes, or his driver's seat. How would you like that experience? Perhaps, ten times a week? How does that affect your life, your family's life, your*

30. This takes our attention to a point prior to the adulthood of any Baby Boomer of today, to a time of post-World War II developments typified by the dismantling of the New York Central and Pennsylvania railroads. Powerful interests were already looting, and destroying key elements of our economy then, but since we still had some of the trappings of the great power the Franklin Roosevelt legacy had mustered, we thought ourselves a prosperous and powerful nation, and continued to enjoy the banquet, overlooking the approach of the day the bill for this folly would be presented to a generation which, then, had not reached adulthood.

31. Those who have enjoyed composer Hugo Wolf's setting of Mörike's *Fussreise*, will understand my point.

community's life, your nation's life, as a whole? What should be—could be—changed about that? Certain changes, and the cruelty sometimes expressed as their effects, must be felt, even much more than merely described.

Presently, we have far too many commuters' automobiles (and also trucks) in operation at any one time.³² We, as a people, waste away large chunks of our lives, in the process. We also spend far too much time and money in the use of foolish fuels, or the use of the useful fuels in the wrong way, or, in the use of fuels in ways which simply should not happen.

That much said on this illustrative case thus far, how does this case relate to our subject here: *dynamics*? Let us restate that question: *Why are so many leading economists of today, such as Myron Scholes, incompetent? Who were the idiots—or, dare we suspect policies inserted by means available to enemy agents, putative allies, or even, perhaps, "traitors"—who destroyed our national railway system and its passenger service, and why did they do it? Was it perhaps, a matter of what is called post-Franklin Roosevelt, Liberal geopolitics?*

The Lesson of LTCM

Where were the professional economists, and their like, while the post-war follies, especially the follies of the 1971-2007 interval, were in progress?

The near-catastrophe caused by LTCM should have taught us two lessons. The first lesson, of limited significance in itself, was the specific type of scientific-technical insanity inherent in the design of the financial forecasting methods which Myron Scholes and his associates crafted for LTCM. The second lesson is, that the same kind of catastrophically failed statistical forecasting method which persists in widespread use today, is the expression of a manifest tendency of bettors at the financial speculator's economic "race-track," to bet collectively on the proverbial "same financial horse": the famous case of Myron Scholes has only typified the touts who all use the same system of financial gambling, and bet more or less on the same proverbial horse.

The question so posed is: If everyone wins, who loses? If everybody loses, who wins? What has been witnessed since my historic announcement in a July 25, 2007 international webcast, is a real-life answer to that paradoxical question.

The result which has been created by such behavior among the leading financier interests of the world today, is reminiscent not only of "Ponzi schemes" and John Law-style "bubbles,"³³ but the Lombard bankers' role in plunging medieval Europe into the New Dark Age of Europe's middle through

32. As relevant experts have emphasized, the ripping-up of rails has put super-heavy trucks on highways and bridges, notably vehicles too heavy to be allowed on many of our bridges, and also much of the existing streets and highways.

33. I proudly confess to having often described the former Federal Reserve Chairman Alan Greenspan as "Bubbles."

late Fourteenth Century. The recent developments of the international markets must be recognized as a clear warning of the threat of an oncoming “New Dark Age,” with certain similarities to that of Europe’s Fourteenth Century, similarities to be recognized in the combined effects of the trends in financial, economic propensities for a virtually perpetual state of wasting warfare under the influence of that Anglo-American faction which President Dwight Eisenhower had already labelled “a military-industrial complex” forty-seven years ago—which was called, by Secretary of Defense Dick Cheney’s circles, a revolution in military affairs, at the beginning of the 1990s, and is, as in the hands of Vice-President Cheney’s ex-Trotskyist, neo-conservative admirers, still, today, the policy of “permanent war, permanent revolution,” which British Fabian Society asset Helphand (“Parvus”) passed to his dupe L.D. Trotsky for the occasion of a then-on-going, London-steered, 1905 Russian Revolution.³⁴

It must not be overlooked, in this connection, that it was the majority of the elected national representatives of the U.S. electorates of those times, who not merely voted for those wasting wars of the 1964-2007 years to date, but electorates which attached themselves to the perpetuation of each of such wars, as if each war were a sort of precious family heirloom of our republic, which, therefore, must be defended by its perpetuation as a state of long, wasting war which London’s infamous “permanent revolutionary” Alexander Helphand admired. This duping of the U.S. institutions and population into this pattern of virtually permanent warfare and matching permanent cultural revolution, was modeled upon the precedent of the foolish, Sophist-ridden Athens’ ruin of itself in its launching of the long Peloponnesian War.

Like the pathetic situation I have described as the presently continuing horde of follies swarming in the large region rallied to the gates of our nation’s capital, the pathological state of economy and popular mind exhibited in that behavior, of that horde, is a reflection of a principle of *dynamics*. It is a

34. It is of continuing strategic significance for the strategic-crisis situation of the moment this report is being written, that what became known as World War I, actually began the day in 1890 when British Prince Edward Albert succeeded in inducing his nephew and dupe the German Kaiser to dump Chancellor Bismarck, thus unleashing the process of pitting the German Kaiser to go to war with Prince Edward Albert’s other nephew, Czar Nicholas II of Russia. This war was brought about through the orchestration of the foolish old Austrian Kaiser’s stubborn determination to have a Balkan war. World War II thus began, actually, with the British monarchy’s control over Japan, a British misdirection of Japan which controlled Japan’s continuing war against China, Korea, and Russia, and which had prompted the original, 1920s Anglo-Japan option for what became the later Japan attack on Pearl Harbor. Such was the sweep of the 1905-1945 interval, which had been set into motion by Britain’s setting Japan into beginning the long, 1894-1945 war against China, which was the setting for relevant, later 1905-1914 developments leading into both World War I and World War II. The name of “permanent warfare, permanent revolution” was uttered by British arms wheeler-dealer and professional organizer of revolutions, Helphand-Parvus. This is the policy of a long list, including Cheney, George Shultz, and the Middlebury monster Felix Rohatyn today.



EIRNS/Claudio Celani

“Bubbles” Greenspan contemplates his next move (cartoon from August 2005).

sickness which could be neither understood, nor corrected except as the crisis this represents today should be regarded as a problem in *dynamics*.

To bring this matter just outlined to a sharp point, the fact that leading influences of the financial community supported the kind of lunacy expressed by the LTCM’s methods, is to be recognized as yet another demonstration of the folly of a brand of thinking about statistical economic forecasting which is fairly identified, earlier, as *Cartesian forms of statistical thinking*. I mean the mechanistic-statistical way of forecasting premised upon ontological presumptions consistent with the dogma of Descartes. I mean Cartesian thinking as contrasted with that method of *dynamics* which Leibniz revived as modern science from the precedents of the methods of the Pythagoreans and Plato.

It is that Cartesian folly which has been carried to a deadly kind of radical extreme by the kind of thinking of the contemporaries of Myron Scholes et al. which were associated with the crafting of the monstrous folly of LTCM. It is the same neo-Cartesian ideology expressed by MIT’s wild-eyed reductionism of avowed Cartesian thinker, and Bertrand Russell follower Noam Chomsky, and Chomsky’s MIT “artificial intelligence” crony Marvin Minsky, as also found among the avowed neo-Ockhamite “artificial intelligence” freaks currently harbored in Silicon Valley.

To restate what I have just written in an appropriate form, this implication of the 1998 LTCM experience, must lead our attention to a fundamental issue of European civilization as that history’s crucial internal characteristics have become fairly known to us as actual, and efficient influences within

European civilization generally, over the breadth of its existence since about 700 B.C. That is, once again: the matter of *dynamics*. To this end, now recall this present report's earlier consideration of the implications of Sarpi's basing the leading ideology of the Anglo-Dutch Liberal culture on the irrationalism of revival of Ockham's proposed alternative to reason.

Put each and all of the list of adducible expressions of the ideologues of Sarpi and his followers, including Descartes, on a display for review. There are many particular, and also important expressions of evil among the elements of that exhibition. However, after examining each case in the collection, stand back for a moment, and pose the question to yourself: "What does all of this variety really come down to?" The answer is: the denial of the fundamental difference between the essential nature of a human being, and of the human species' existence thus far. The answer to that question must be: *the sovereign potential of the individual human mind for the quality of creativity which is absent from all lower forms of life, and from any possible design of a machine.*

It should be made clear, here and now, that the essential evil afflicting society now, not only in the U.S.A., is the policies of practice which act in defiance of the essential nature of the human individual and species, which seek to suppress that nature, as the motive for this suppression is to be attributed to the legend of the Delphic Olympian Zeus. It is this which, for example, underlies the evil done by LTCM and others in expression of Scholes' forecasting ideology.

That specific kind of denial is the axiomatic-like root of the syndrome which I have summarily described here as the greater Washington, D.C. area's self-destructive syndrome of, especially, the 1971-2007 interval to date. The presently on-rushing state of global catastrophe must be traced immediately from the radical changes associated with the political rise of the so-called "68ers" over the 1968-2007 interval to date, but the roots were already cultivated under the long-range, British Fabian influences centered in the closely associated circles of the trio of the Lucifer/Lucis cult's Aleister Crowley, Bertrand Russell, and H.G. Wells of the 1920s and 1930s.³⁵

Mutual associates of the trio included the cases of Aldous and Julian Huxley, and George Orwell. Aldous is particularly notable for his pioneering role in the pro-satanic rock-drug-sex counterculture which erupted as a mass effect during the 1960s, and the overlap with the work, such as the synthesis of LSD by the London Tavistock Clinic which had been founded by British intelligence's Brigadier General John Rawlings Rees. Notably, this element of British intelligence played a

35. Crowley was the founder of a set of explicitly satanic cults, while the Huxleys experimented with drugs under his sway, and Wells was key, as his *The Open Conspiracy* and Russell's public endorsement of Wells' book indicates.

key role, under such covers as the Josiah Macy, Jr. Foundation's Cybernetics project and the related work of Professor Norbert Wiener and John von Neumann, in the darker side of so-called "information theory" and "artificial intelligence." Where Alexander Helphand's ties to British intelligence operations, including organizing wars and weapons-trafficking profits from those wars, had begun, during the early 1890s, under the sponsorship of the British Fabian Society, which then planted him, with help of a personal meeting with then aging Frederick Engels, inside the German Social-Democracy's press, the central feature of Russell's career was his life-long commitment, as an adult, to the destruction of what he hated as the science of Kepler, Leibniz, Gauss, Wilhelm Weber, and Bernhard Riemann. Russell played an associated role in the destruction of the mathematician Georg Cantor, and the training of the two wretches, Professor Norbert Wiener and John von Neumann, who committed their adult lives to disrupting science and the destruction of the creative powers of the human mind through "information theory." The common feature which united such apparently diverse types of Fabians as Helphand, Crowley, Russell, and H.G. Wells, is the orchestration of diverse elements which combined "permanent war and permanent revolution," to the esteemed geopolitical advantage of an Anglo-Dutch Liberal domination of the world. "Information theory," as developed under Russell protégés Wiener and von Neumann, was among those means of the psychological-warfare methods developed with aid of the work of Rees's London Tavistock Clinic. The promotion of a recreational-drug culture, within the post-World War II U.S.A., and elsewhere, was a crucial element in this imperial scheme.

The most important of the strategic lessons from the known history of human societies and their conflicts, is that culture, "the battle for the control of the target's mind," is the primary weapon of strategic warfare. That is the key to understanding how the U.S.A., which President Franklin Roosevelt defended so well, has been destroyed through long-ranging, corrosive forms of cultural warfare, since the day that President Roosevelt died. The ideas which controlled the mind of the policy-shapers associated with the LTCM operation, is a prime example of the way in which this aspect of cultural methods of strategic warfare works. The game being played to such and related effects was the induced self-destruction of our U.S.A., with the view that once we were destroyed in our role as a powerful economy, the world would be open to secure a durable world-empire of the type which is named today "globalization," "one world," or "world government." The traditional name was "empire," more or less as Gibbon had promised—not King George III, but—Lord Shelburne. That has been the intention of our leading adversary since before the day the U.S. was founded, and especially since the aftermath of Appomattox.

Those self-esteemed political, economic, or military leaders among us, who do not recognize this fact, are to be regard-

ed as incompetent leaders in our nation's defense, accordingly, until they improve their thinking accordingly.

2.20 The Principle of Dynamics in Economy

Our subject is now *dynamics* itself.

Recall this report's earlier account of Paolo Sarpi's choice of Ockham as, simultaneously, a replacement for Aristotle, as a choice which would allow a desired margin for innovation in society's economic and related practice, but would, nonetheless, also provide an ideological barrier against the spread of general knowledge of scientific principles and method as such. This became known as the form of organized irrationalism called the Anglo-Dutch *Liberalism* of Descartes et al. On that account, it is essential to recall, that the latitude which Ockhamite dogma afforded society, did nothing to bring to an end the form of regimes associated with the oligarchical model, neither that of Sarpi's Venetian factional rivals, nor that of the tradition of the fabled Olympian Zeus.³⁶ As I shall show here below, Sarpi's intention on this account is fairly described as a policy of "Let the (human) cattle out of the barn, but keep them penned up in the oligarch's farm-yard."³⁷

This method of Sarpi's became also known as *empiricism*. The effect of this induced belief on the intellectual and moral conduct of the victim, is often described as "human nature."

From the standpoint of political-economy, Sarpi's adoption of Ockham meant either eliminating the use of principles of science, or keeping knowledge of the existence of such principles from even most among the better-educated segment of the population in general. In place of the suppressed concern for actually natural principles, the followers of Sarpi employed the sly ruse of substituting a Sophistical "explanation" of a discovery; this explanation was used as a replacement for, and precaution against, an actual, conscious experiencing of the relevant, valid act of discovery. The act of merely repeating a learned technique, was substituted for the relevant, conscious act of actually discovering the physical principle which did, or might underlie that technique.

It was from among the opponents of both the old and new Venetian parties, such as Cusa, Kepler, Leibniz, et al., that the principle of *dynamics* was explicitly revived by Leibniz him-

36. Shades of *Don Giovanni's* Leporello: Sarpi would probably have endorsed the recommendation made to Shelburne by his lackey Gibbon, that Shelburne marry the British Empire to the legacy of the Eastern Roman Empire's Julian the Apostate.

37. See the treatment of a closely related subject, the intentional fraud expressed in the presently customary effort to equate political freedom in a true republic with "Liberalism."

FIGURE 4

The Mediterranean Littoral, Birthplace of European Civilization



EIRNS

Centers of civilization in the early first millennium B.C.

self, revived as what he described as his revival of a principle of knowledge which had already been held by some leading parts of Greek civilization, as by the Pythagoreans and Plato, prior to the appearance of Aristotle or Euclid.

The point to be stated and developed at this point in the report, will be mentally challenging to most readers; but, if we wish our civilization to come out of the already onrushing world financial collapse successfully, it is extremely important that our people, especially those in positions of influence over society's policy, "stick with it," and make this knowledge, which I am presenting here, their own. Our nation's future will now depend upon the choice of leaders who do just that.

At this point in the report, the issue of Euclid's ideology, we must now focus the responsible citizen's attention on the crucial core of the ideological problem which has been the principal cause for permitting the introduction of those policies under whose influence the presently onrushing, economic breakdown-crisis has been crafted.

That said, now look back to a time not long after the death of Classical Greece's famous Plato, a time when European civilization was still very young. Look at the relevant portions of the map of the area of the Mediterranean and its littoral where the birth of European civilization occurred.³⁸ The

38. The fact that the principal settlements of a rising Mediterranean civilization, were based on coastal harbors' settlements, whose defensive fortifications were to the interior land areas behind, reflects the reality that the primary development of European civilization after the initial ten thousand years of the great glacial melt was rooted in maritime cultures whose inland extensions proceeded from initial maritime cultures' colonization of river mouths, and then moved inland along upriver routes. The initial colonization of Mesopotamia, as Sumer, by a non-Semitic culture associated with a maritime culture from the Indian Ocean region, also reflects this. See Herodotus. My own studies of the character and devolution of the pre-Semitic, Sumerian

historical material which I am now about to refer to your attention here, identifies those foundations of European civilization which were known since prior to the birth of what we know as Classical Greek, post-Homeric culture. These issues were known, not only known to the Pythagoreans and other circles of Plato's friends and acquaintances from that time; but, the foundations of that knowledge had been given to them from Egyptian culture, probably traced to such sources as the section of the Egyptian priesthood customarily associated with the location of Cyrenaica.

Look at Cyrenaica at about the time of the Pythagoreans and Plato, a place on the map of those times, from which the future, Aristotle-hating Macedonian, Alexander the Great, would be descended, by way of his mother's side of the family.³⁹

We live today, as the greatest theologians would agree, within a vast, intrinsically dynamic, simultaneity of eternity, a vast span of physical, and spiritual space-time, within which relations among entire local periods of history, among cultures, and among persons, assume a specifically *dynamic* quality, as the Pythagoreans, Plato, and Leibniz have supplied the true meaning of *dynamics*. Since what I am writing here represents an approach to the subject of the way in which dynamics shape the cultural history of and among those past peoples and nations from which our present U.S. expression of European civilization has been developed, we should see ourselves, our nation, and our world in those terms of reference.

Therefore, for our purposes stated here, we should recognize an ancient, real Cyrenaica toward which you must rec-

colony and its immediate outgrowths, during the middle to late 1950s, already presented me with devastating evidence for a maritime-based, upriver pattern of development of a post-flood civilization, as opposed to the contrary "hydraulic" speculation.

39. Some of this information, later confirmed by me, was referred to my investigations by a certain Criton Zoakos, during one of his earlier political incarnations. He later went over to the proverbial "other side," but past good deeds, such as some of the earlier work of Leonhard Euler, or Benedict Arnold, should be remembered, and acknowledged, even now.

FIGURE 5
Eratothenes' Method of Measuring the Size of the Earth

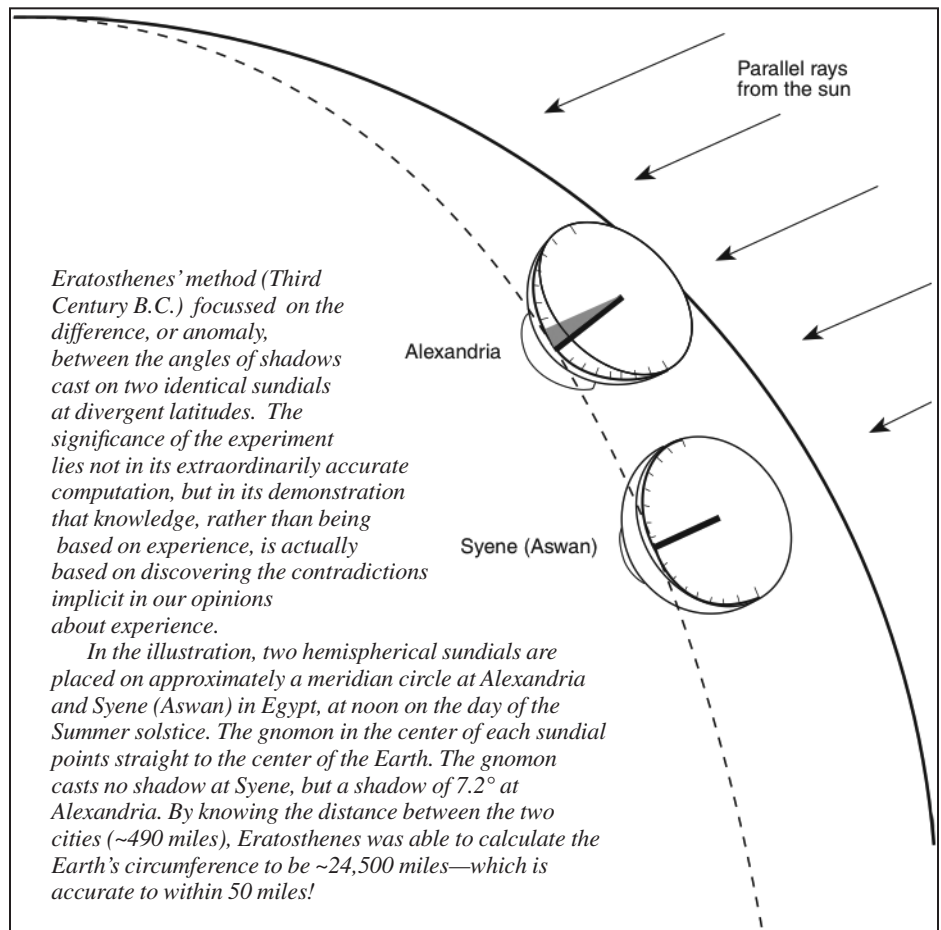

ognize in your imagination, a place which had been quite beautiful during those ancient times. It had been a time which should continue to be noted for its association with the heritage of a long-standing skill in oceanic navigation traced to origins as old as man's knowledge of the Zodiac. Then, trace the tradition of the Pythagoreans and Plato, as continuing up through the lifetime of the Platonic Academy's great Eratosthenes, who became the first to measure the longitudinal great circle of the planet Earth, by measurements based on two chosen points within Egypt. The dynamics specific to the history of the entire region in which the historical foundations of modern European civilization repose, will not allow us to overlook the facts, that Eratosthenes was Cyrenaican by origin, developed as a member of the Platonic Academy and brought into Egypt, where he rose to the pinnacle of known leadership in science in his time. The characteristics of the relevant, known Pythagorean and Platonic thinking, which he reflected, correspond to the experience of a certain kind of astronomy, an astronomy which reflected a very long background of experience transmitted from the calendars accumulated by many, many generations' experience and work

within the context of transoceanic astrogation.⁴⁰

In this connection, recall my earlier reference, here, to the fact, that the subsequent appearance of modern European science, about 1,700 years later, had depended in a crucial way on Nicholas of Cusa's discovery and correction of the profound error of principle to be found in a work by Eratosthenes' contemporary and correspondent, Archimedes of Syracuse's erroneous quadrature of the circle. This error, which reflects the influence of teachings such as those of Euclid, had not existed in what we know as the work of the Pythagoreans at the time prior to the death of Plato, nor does it appear in those sources on Eratosthenes' own work which are known to me.

2.21 *Euclid's Political Crime*

The point to emphasize at this point in this report, as we focus attention on some history from that part of the map, is that these Pythagoreans of Plato's lifetime (and earlier) had rejected, as Bernhard Riemann did in 1854, the use of what are called *a priori* definitions, axioms, and postulates which were associated, later, with Euclidean geometry.⁴¹ We also

40. Compare this with the matter addressed by Bal Gangadhar Tilak in his *Orion* and *Arctic Home in the Vedas*. The astronomical data used by Tilak was chiefly from relevant modern German and related professionals, but Tilak's scholarly facility in Sanskrit and Vedic, was crucial for his treatment of that evidence from the standpoint of the culture to which the astronomical evidence referred. *Orion* takes us to a dating of about 6,000-4,000 B.C., when the maritime cultures typical of a civilized people dwelling in the aftermath of the most recent great Ice Age, would have moved up rivers into the relevant "recovering" interior of the continents which had been long dominated by the weight of the glaciation. The implicit antiquity of the knowledge celebrated in the design of the Great Pyramid of Giza, has similar implications.

41. Bernhard Riemann, op. cit. The relevant precedent for Riemann's action had been set by Carl Gauss's teacher Abraham Kästner (1719-1800), who became Germany's outstanding historian and teacher of mathematics, and who, not coincidentally, had hosted a visit from America's Benjamin Franklin at Göttingen during the 1760s. Kästner had specified the need to develop an *anti*-Euclidean teaching and practice of Germany. However, with the rapid degeneration of the reigning culture of Europe, under the combined impact of France's Jacobin Terror and the reign of the predator, and Lagrange patron Bonaparte over most of continental Europe, it became "politically correct," especially after the Duke of Wellington's role in appointing the Restoration monarchy in France, for professors of mathematical physics, such as Carl Gauss, to conceal any visible attachment to the personality of the same Kästner who had been the key figure behind the Classical revolution spread from Germany through Gotthold Lessing, Moses Mendelssohn, et al., and, later, Goethe, Friedrich Schiller, and the celebrated Humboldt brothers. Kästner student Gauss, who had adopted an anti-Euclidean geometry during his years of association with his teachers Kästner and Zimmerman, later acknowledged that he had developed a conception of anti-Euclidean geometry during his youth; but, he refused to discuss the content of the matter when challenged on this point by Jonas and Wolfgang Farkas, and other correspondents, later in life. Looking at Gauss's now published work from the vantage-point of Riemann's reading of it in the already referenced 1854 *Habilitationschrift*, Gauss's conception was the foundation for Riemann's anti-Euclidean geometry, not the non-Euclidean work of Lobachevsky and Bolyai (which Gauss had examined). Cf. historian Kurt-R. Biermann, *Carl Friedrich Gauss: 'Der Fürst der Mathematiker' in Briefen und Gesprächen* (Munich: C.H. Beck, 1990) for some recently updated, relevant documentation from Gauss's correspondence.

know, as a matter of contrast, that Euclid had been educated under the influence of those enemies of the Pythagoreans and Plato, the Sophists, who are the ancient forerunners of the medieval Ockham and modern Sarpi.

We know that most of what are associated with those theorems of Euclid, reflected previous origins, a generation or more earlier, for those discoveries which have any important expression of validity within Euclid's work still today. Those earlier discoveries had actually been made in an essentially different way, chiefly by the Pythagoreans and Plato's other circles, or passed down from the like of Thales and Heraclitus, earlier.

Today, more than two-and-a-half millennia later than Socrates, Archytas, and Plato, modern science has discovered that the *a priori* definitions, axioms, and postulates of Euclidean geometry, at least as these are given still today, in publications of *Euclid's Elements*, were premised, vigorously, upon superimposed, false definitions and other false assumptions! The significance of that modern re-discovery was first stated explicitly, in relevant published work, by Bernhard Riemann, as announced in his 1854 habilitation dissertation, and was later implicitly affirmed for physics, by Albert Einstein, as, also, by Academician V.I. Vernadsky.

Nonetheless, Riemann's work was also a rediscovery of the foundations of geometry which had been, already, implicit in the development of modern science by Nicholas of Cusa and his followers, such as Einstein was to emphasize, later, Johannes Kepler.

Today, we are able to verify, beyond doubt, not only that modern anti-Euclidean *physical geometry*⁴² conforms essentially, in effect, to the thinking of the Pythagoreans and other associates of Plato; we know that Euclidean geometry was never actually necessary for science! Ah, but there is a reason for all of this, which it is important for any student of science

42. All consistent mathematics as such, reflects obviously underlying ontological, axiomatic-like presumptions, which, however strenuously "pure" mathematicians may attempt to hide this fact, are "secretions" rooted in the physical geometry inherent in the processes of the individual human thinking mind. Thus, as Kurt Gödel emphasized in his own way (1930-1931), no completeness exists for any formal mathematical system. Gauss's treatment of quadratic reciprocity illustrates exactly that point. Thus, as I am prompted here by a very recent occasion to review their examination of Gauss's third proof of his notion of quadratic reciprocity (*Werke II*, pp. 2-8) with some among my collaborators, it is obvious to me that the real foundation for Gauss's argument for the startling expression of quadratic reciprocity, reflects the implicit reality, that the assumptions of arithmetic are not pure, but, as many of us have insisted, repeatedly over generations, lie within the domain of the ultimately *physical geometry* of the biology and metabiology of the human mind-function. Hence, the physical reality underlying this discovery of quadratic reciprocity, initially, already by the young Gauss. This same problem is echoed by what Riemann was to identify as Dirichlet's Principle, and the expression of this implicitly dynamic conception in his development of Riemannian hypergeometry. This is the core of the demonstration of the functional possibility of a Riemannian *physical science*: hence, the insertion of this note here is of considerable relevance to the present writing's subject of the actual dynamics of economy.

today to know, to know the damage to the mind which Euclid's *apriori* method actually worked.

That much said, the point on which we must focus at this moment, is the nature of the fraud perpetrated either by Euclid, or in his name.

2.22 Sight & Sound

We have, thus, reached the point at which we shall begin to expose the significance of dynamics, and show the role of dynamics both in physical science as such, but, also, the essential role which dynamics must play in the study of social processes on a mass scale, social processes such as economies, where the principle of dynamics is indispensable for such functions as competent long-range forecasting.

Each time we might enjoy the experience of a truly fundamental act of discovery in science, we should be reminded that fundamental discoveries are always elementary, but truly elementary only in their own fashion. What is elementary, on this account, is the nature of the relationship between the world outside our skins, to processes internal to our minds, as this is mediated through those biological instruments which are our organs of sense. These senses may be regarded as instruments, in the sense of the kinds of apparatus which serve as scientific instruments. In the human individual, these instruments of sense-perception, are ordered, in rank, in priorities, from sight, hearing, on down. For our purposes in our discussion at this juncture, I limit my attention to sight and hearing.

How, then, do we actually know, or not, that which we may have believed that we have sensed? The most directly available answer to that most important question, is provided, as illustration, by the case in which the supposed object or action observed, is simultaneously the subject of as least two senses, such as sight and hearing. Kepler's use of harmonics, in his crafting of the general formulation for the Solar system of gravitation, is the simplest and most famous illustration of that fact, and, otherwise, also the trigger for the explosions of pure rage, even from among many otherwise gifted scientists, when this exposure of the fallacy of aprioristic "sense-certainty" is posed for consideration. Contrary to Euclid's aprioristic practice, in real life, no sense-experience is to be taken on proverbial "face value" as a true representation of the functional role of the phenomenon in question. For human beings, the true organ of *good judgment of sense-experiences*, is the human mind, not the mere experience of sense-perception as such.

The strong proof of this function of the human mind, as relative to the senses, is the functional role of human creativity in making discoveries by means of which mankind's power over the surrounding world is increased, manifestly and abundantly, by society, as no animal species can willfully increase the ecological potential relative population-density of its species. Thus, the most interesting experience is experience of a valid such, demonstrable discovery of a physical or comparable principle through which the "ecological" poten-

tial relative population-density of society is increased, per capita and per square kilometer. This increase does not occur willfully in any presently known living species, excepting mankind.

To state the point in its simplest terms of valid approximation: this ability to conceptualize the practicable validity of a discovery of principle to this effect, is the available standard, for those living each within our own respective skins, for the individual human's mind's defining a functionally valid image of the phenomena which the senses have detected.

The import of what I have just written here, on this specific point, thus far, is made more accessible by comparing the function of our senses to that performed by other kinds of scientific instruments, such as those of some laboratory apparatus.

Take the following case as an illustration of the point I am making at this immediate juncture.

There is a point of smallness, proximate to the atomic scale and below, in the physical-experimental domain, at which the human senses can go no further in their attempted *direct* explorations of the very, very small, except through the aid of "artificial" instruments, functionally analogous to the work of our senses. Through these instruments, we gain access to certain degrees of actual knowledge of what is occurring, for example, within a regime of otherwise inaccessible smallness, or, conversely, for studying phenomena in the very large, as on the vast time-scales of coherent forms of galactic or supragalactic processes of developments. Compare these two illustrations of the point with a third case: the development of prosthetic instruments and techniques for providing a person a way of approximating a lost kind of sense-perception, illustrates the point.

This matter of "artificial instruments of sense" used in the laboratory, or kindred applications, does sometimes lead to nonsense-conjectures. What frightens, or simply infuriates some poor fellows, is the fact that some atomic and sub-atomic processes must be treated as expressions of "wavicles," as both particle and wave in form, but also precisely, like a slime-mold, neither. Accepting the physical-experimental evidence for the existence of Planck-like "wavicles" on the sub-atomic scale, comes very hard for some people, especially hard-boiled statistical reductionists such as some particle-worshippers from among the nitty-gritty devotees of Ernst Mach. Yet, this experience from microphysics, was only an echo of the hollering-and-bellering which is triggered in certain places, when reference is made to the role of harmonics in Kepler's discovery of the general principle of gravitation, a discovery made by focussing on the adducible system of harmonic organization among the orbits of the Solar system as a whole.

What remains clear to some among us, at least, as, famously, by the Christian Apostle Paul,⁴³ is that the world of

43. *I Corinthians* 13.

The Keplerian Revolution

In pathological mathematical methods, such as those used by the followers of Ptolemy, Copernicus, and Tycho Brahe, physical processes are merely described by the method of connecting observed points (“dots”) in ways which presume that all observed processes can be explained mathematically, as if at the blackboard. The diagrams shown here are from Kepler’s New Astronomy.



Claudius Ptolemy
(2nd Century A.D.)

The diagram is Kepler’s representation of Ptolemy’s geocentric worldview. The Earth is at point K; the Greek letters show the paths of the apparent motion of the Sun and other heavenly bodies, travelling around in epicycles. These were purely geometrical constructs, required to “save the appearances”—or permit prediction of astronomical phenomena. Ptolemy made no claim to describe the physical reality which would make such bizarre movements possible.

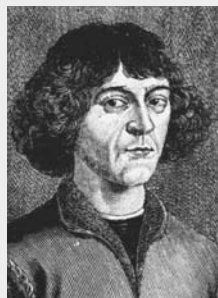
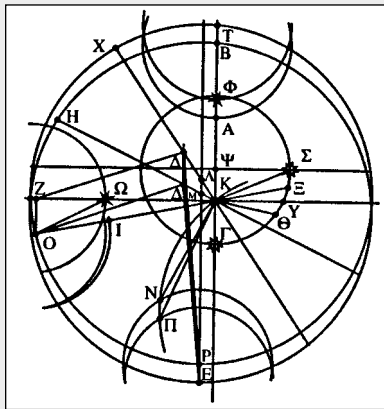

Nicolaus Copernicus
(1473-1543)

His model of the cosmos moved the Sun to the center (at K), but still required a plethora of epicycles in order to “save the appearances,” because it was not based upon understanding of the physical causes of the motion of the heavenly bodies.

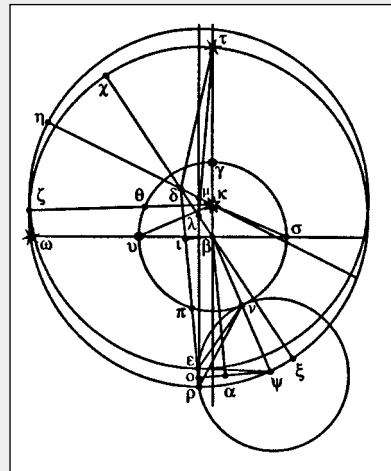

Tycho Brahe
(1546-1601)

Tycho’s construct was an attempt at a compromise between the Ptolemaic and Copernican models. The stationary Earth is at C. The Sun (S) revolves around the Earth, as do the “outer” planets (Mars, Jupiter, Saturn); the “inner” planets (Mercury, Venus) revolve around the Sun.

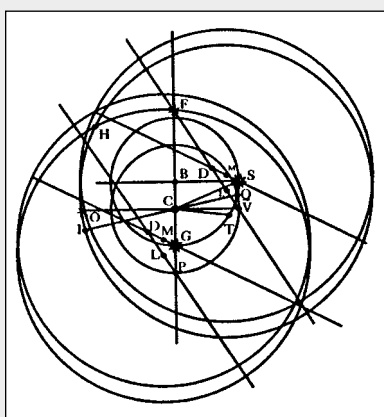

Johannes Kepler
(1571-1630)

For Kepler, the trajectory of action is determined by universal physical principles, not by “connecting the dots.” This diagram is one of many in the New Astronomy, by which he charts his discovery of the elliptical orbits and the principle of universal gravitation.

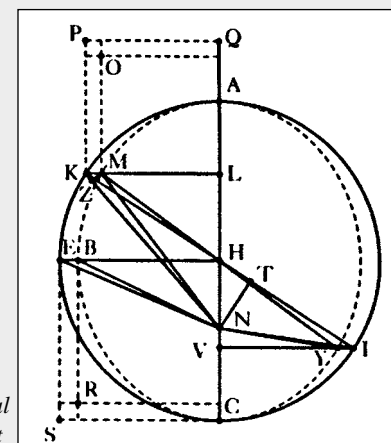

sense-certainty, is a world of shadows of reality, not reality itself, not reality in its efficient form of actual existence, but, at best, merely a shadow cast by that real world which we do not see directly. Neither sight nor sound, for example, present

us with proof that a sense-perception is a direct representation of what is actually being experienced; above all, it does not show us why and how that experience is actually, necessarily generated. Take the case of the discovery of universal gravita-

tion, which was a unique accomplishment of Johannes Kepler.

Although Kepler referenced the work of Copernicus in some detail, and also the work of Tycho Brahe, neither of those two ever discovered the physical principle by which the Solar system is organized; Kepler did. The work of Brahe, for example, has been certified by modern scientists as meticulous, allowing for some very significant errors in measurement of observations which Kepler corrected. Whereas the Roman Claudius Ptolemy's system had been an intentional fraud, the awesome mistakes in Copernicus's and Brahe's representations, were not essentially the product of flaws in observation, but in their ontological misconceptions of what those observations actually showed, in reality.

This comparison of those relative failures by Copernicus and Brahe with the successful discoveries of Kepler, represents much more than the founding of modern astronomy. As Einstein's summation of the point emphasizes, Kepler's methods of discovery have served as the genesis of competent experimental practice for all valid enterprises in modern experimental physical science, from the setting of the discovery of the principle of universal gravitation, uniquely, by him, onwards.

All competent modern scientific practice, and therefore also all competent economic practice, including making and shaping of economic policies of nations, and of the world at large, and even exploration of near-by Solar space, depends, critically, as Albert Einstein emphasized, on the foundations laid in the connection of the successive discoveries of Kepler and Bernhard Riemann.

Kepler provides indispensable background for all modern scientific and economic practice. Successful exploration of nearby space would be impossible without his contributions: not only for his particular discoveries, but for his way of thinking.

He also expresses this significance, as for the point about perception which I have introduced at this juncture of the report, because the key fellow who did the most to attempt to fake a Sophistical perversion of Kepler's discoveries into the accounts of Seventeenth- and Eighteenth-Century European science, was Galileo Galilei, that household lackey of Paolo Sarpi, who could never discover, during his time spent within the Seventeenth Century, what an actual catenary ("funicular") curve was, even though the Fifteenth-Century Brunelleschi had used the catenary as an instrument for construction of the seemingly impossible cupola on the most famous Cathedral of Florence.⁴⁴ Indeed, if Galileo had examined that cu-

44. The catenary function is a crucial feature of the discovery of the universal principle of physical least action, by the collaboration of Gottfried Leibniz and Jean Bernoulli. This was a key feature of the entry into Nineteenth-Century accomplishments of Lazare Carnot and the Ecole Polytechnique under the direction of Gaspard Monge, which led, in turn, by the late 1820s appearance of *Crelle's Journal*, to Germany's world primacy in Nineteenth-Century science, under the impetus provided by the circles of Alexander von Humboldt, Carl F. Gauss, Wilhelm Weber, Lejeune Dirichlet, and Bernhard Riemann.

pola as I did in my time, the catenary principle could be clearly seen with the naked eye at even a significant distance, near to the city, from that structure.⁴⁵

Kepler made two very crucial discoveries which are eminently appropriate illustrations of the kind of approach to economic thinking, which is needed to pull our republic back from the edge of the abyss where the world's economy is lurching to and fro at the present moment. The first was his discovery of the principle of gravitation with respect to the relations among the Sun, Earth, and Mars; the second was the discovery of the harmonic ordering among the Sun and planets, on which the general principle of gravitation depended. Both of these two discoveries by him are of crucial relevance for illustrating the general way in which Sarpi's Liberalism has continued to wreck much of the work of science to the present day. I shall summarize that point as briefly as permissible now, with the intent to use this case as a platform through which to access the subject of the role of dynamics in shaping the needed economic-recovery programs of a world presently entering what may be described, without exaggeration, as a shattered state.

2.23 Howling & Gnashing of Teeth!

During a meeting of the Fusion Energy Foundation (FEF) at Ibykus Farm during the mid-1980s, I had the occasion to suggest that we must reconsider certain traditions in contemporary scientific doctrine as suffering from a lack of regard for the crucial features of the work of Kepler. I pointed to the role of harmonics in Kepler's generalization of the principle of gravitation for the Solar system. Some of the scientists at the table exploded where they sat! Except for a few among us, such as a serene and sovereign Professor Robert Moon, the best of the scientists among us, their rage would not be stilled. At a subsequent meeting there, of approximately the same roster of participants, months later, the discussion of the topic resumed, this time in a more even-tempered setting, but the crucial issue was touched on only very, very lightly, and that largely by indirection.

My point in that intervention was the same issue which I have developed to this present point, in the preceding observations on the discrepancy between a literal reading of mere sense-perception and physical-experimental proofs of reality. The explosion of rage which greeted my remark, was a knee-jerk reflection of the depth of the passion buried under decades of pro-empiricist brainwashing in the reductionist ide-

45. My recognition of this experience struck me months after I left. This belated recognition threw me into an excited state. I communicated this and my conclusion to the relevant scientist in Florence, who concurred with my recognition of the fact, and later, provided me with more detail confirming my related conclusion about the process of construction itself. This incident told me much about the culture of Florence at that time, and, therefore, about the setting in which Cusa operated in that city, and the quality of relevant influences on Leonardo da Vinci. All truth exists as an expression, not of an event, but an historical process.

FIGURE 6
Kepler's Harmonics

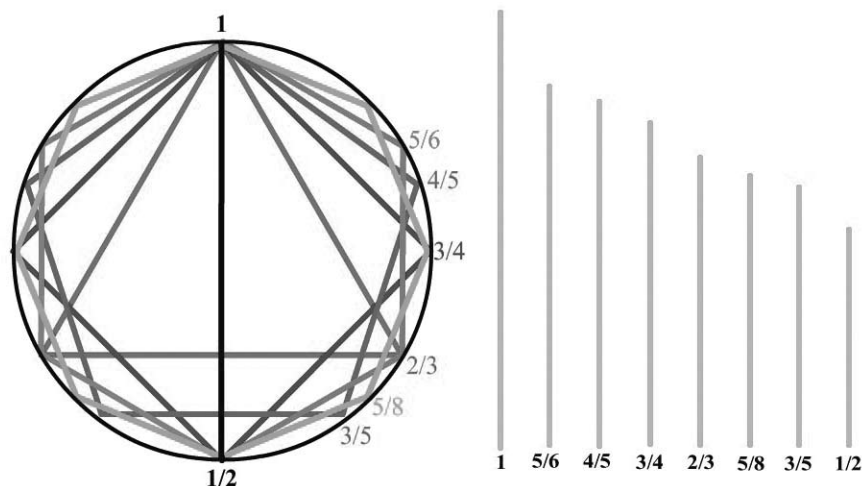

*In his 1619 masterwork, **The Harmony of the World**, Johannes Kepler defines mankind's relationship to physical principles, specifically harmonics. Harmonic proportions are expressed geometrically by a complete circle and its parts, demarcated, in equal divisions, by regular polygons. Although harmonic proportions are expressed in what we see and hear, the universal principle of harmonics cannot be located in the objects of sense perception; it is an expression of a higher domain. Harmonics must be "heard" in the mind, through the ironic juxtaposition of what you see and what you hear. You have to train your mind to "see" what you hear and "hear" what you see. Harmonics are indifferent to senses. We live in one universe, which we perceive through many senses. Kepler's brilliant application of the principle of harmonics to the planetary orbits has been, for nearly four centuries, and remains today, anathema to Newtonian/Cartesian scientists.*

ologies of Euclid, Descartes, et al. Apparently, the wolf is dangerous when he prowls in deadly silence toward his prey; but, when the wolf has nothing better to do, he howls.

The rage to which I have referred is not merely an intellectual disorder. As some associates of the scientific association discussed that incident some years later, the problem which had prompted that earlier howling, had been the ugly reality, that science today operates under the tyranny of a virtual Babylonian priesthood, whose role is expressed in a concentrated way in the "peer review" functions adopted by certain presumably prestigious institutions, such as scientific and related journals, and *de facto* representatives of the present-day descendants of the Babylonian priesthood, placed in the most influential academic and related institutions. Careers of great merit can be ruined, permanently, in almost an instant, at the drop of a handkerchief from a relevant "peer review" agency. Like the *vox populi* of the imperial Roman arena, a simple gesture of "thumbs up" can make a hero of a virtual braying jackass, and often does, or a "thumbs down" can spell one kind of doom, or another, for the career and remainder of the social life thereafter, of another.

Therefore, it is often the case, that when an accomplished scientist prepares to present his validated achievement before

the blackboard, he will weave in sundry silly fragments of deference to the peer-review process's high priesthood (or, the classroom spies), and present his case in ways which do not conform, as a report, to the way the actual, valid work, as in the laboratory, proceeds.

The case of former Vice-President Al Gore's claim to the authority of a supporting a "consensus" for "inconvenient," anti-scientific drivelings, represents a caricature of the profound and extensive corruption which has prevailed, even among actually reputable scientific institutions, which Gore et al. are decidedly not. Scientifically, Gore's fraudulent drivelings are not worth discussing in connection with science, but should be referred to sessions of some Liars' Club, or some darker corner in jurisprudence. The fear expressed as rage by the scientists at my indicated meeting, reflected a deeper problem, a problem in the elements of willful miseducation, like that directed by a virtual Babylonian priesthood, to which they, like my own relevant adolescent and later peers, had been subjected since childhood, already in their secondary and undergraduate education. It is that

problem which not only deserves to be addressed, but which is of crucial importance for the shaping of the new policies which the presently onrushing world economic-monetary breakdown-crisis implies.

The focal issue is, as I have already indicated here, the problem which must be posed, as I do here, by considering the implications of the qualitative difference between the view of the same phenomenon from the respective standpoints of vision and hearing. Howling and shrieking over the role of harmonics in Kepler's solution for the general principle of gravitation within the Solar system, is both a model example of the issue I am addressing at this point, and also the most revealing expression of the effects of Cartesian-like fallacies of composition spilling over into the domain of science and the customary misshaping of public policy generally, still today. It is that kind of misguided habits of thinking, especially in our society's policy-shaping circles, which must be addressed and changed, if our republic is to survive in some recognizable semblance of itself, even during the relatively very near future ahead.

In respect to the point I have just made in the preceding paragraph here, the scientists to whom I have referred, obliquely, as attending those sessions, had solid records of ex-

perimental achievements and occupied highly respected positions in the community. Those who exploded were from among the relevant most reputable achievers of their time. My conclusion from that and related experiences, was a recollection of the fact of a deep difference between science practiced as in the experimental laboratory, which was characteristic of most among them assembled there, and science as “explained” before the blackboard, or in similar fashion, in a setting of peer review, as it were before a blackboard.

My own particular authority, and accomplishments, in this setting, rested chiefly, then, as today, upon my unique achievements, respecting both actual forecasting and matters of principles, in economics practiced in consistency with the Hamiltonian American System, as a branch of physical science: rather than the customary “fifty-seven” varieties of monetarism. My most significant particular contribution to the field, came as my tackling the issues of forecasting from the vantage-point of Riemannian dynamics. Back in the middle to late 1950s, I labelled this “dynamic economic modelling.” My chain of uniquely successful long-range forecasts, over the period from the late 1950s to the present, has been premised on both that method as adopted then, and as developed over the course of the decades since.

Since I am the only visible authority on the subject of economy who has consistently understood the process which has led, step by step, over the span from the 1950s to the present global eruption, and since I have never been remiss in disclosing the premises and methods of my relevant argument, my experience in this field, arguments whose beginning can be traced explicitly from the effects of my 1948 encounter with Wiener’s *Cybernetics*, my argument carries its own relevant scientific authority, whenever my forecasts are considered as I actually formulated them, but not as the simplistic paraphrases uttered by those racetrack-variety bettors who wished a precisely timed single prediction for the purpose of placing gamblers’ bets on the precocious ejaculations performed by financial markets.

These accomplishments of mine on that account, have always had deep epistemological foundations, considerations which had always been more or less freely available to those who cared to discover them. My forecasts have been the best available in the public domain; but, it is the method which underlies the presently manifest, repeated successes of those forecasts, which is the important issue for people living inside the present moment of world crisis.

Therefore, I must report here, that the starting-point for this was my encounter with a pre-publication review copy of Professor Norbert Wiener’s 1948 *Cybernetics*. A clever book, if that author had stayed with a charming discussion of gad-

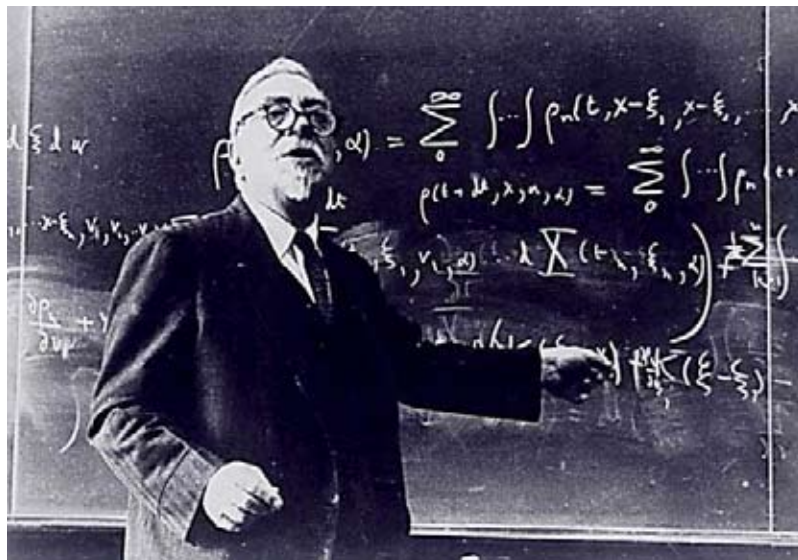

Norbert Wiener’s “lunatic doctrine of ‘information theory,’” LaRouche writes, “was clearly a menace to both the progress of science and progress in the technology of production.”

getry, including some matters bearing on weapons-systems; but, his presentation of the lunatic doctrine of “information theory” was clearly a menace to both the progress of science and progress in the technology of production. Wiener’s subsequent *The Human Use of Human Beings* unmasked the fellow completely! By early 1953, I had become a committed follower of relevant aspects of the work of Bernhard Riemann, which provided needed insight into the way in which the concept of dynamics must be introduced into the treatment of economic processes as systems.⁴⁶

My particular emphasis in this reaction against Wiener and von Neumann (most emphatically) was on the principle of human creativity, a concept which could not be tolerated by either of this pair of logical-positivist fanatics. This was the problem addressed by Carl Gauss’s 1799 doctoral dissertation, but in its extreme expression. This is key to von Neumann’s foolish assertion that there is no obstacle in principle to developing a digital computer, or something similar, which could supersede the need for existence of human brains.

From the standpoint of mathematical-physical formalities, the issue of creativity is what is typified by the role of what is rightly termed the *ontologically infinitesimal* form of the local expression of a universal physical principle in the extremes of the very, very small. It is precisely that concep-

46. Over the course of the 1950s, I tracked down the root of the hoaxes of both Wiener and John von Neumann (*The Theory of Games & Economic Behavior* and the Yale lectures, *The Computer and the Brain*), to the common root of the streak of lunacy I encountered in both of these gentlemen: both were products of Bertrand Russell, and both had been kicked out of Göttingen, by David Hilbert, for very good reasons of incompetence and, also in von Neumann’s case, charges of plagiarism. Admittedly, Hilbert had his own problems, but in these cases the issues and the charges were clear-cut.

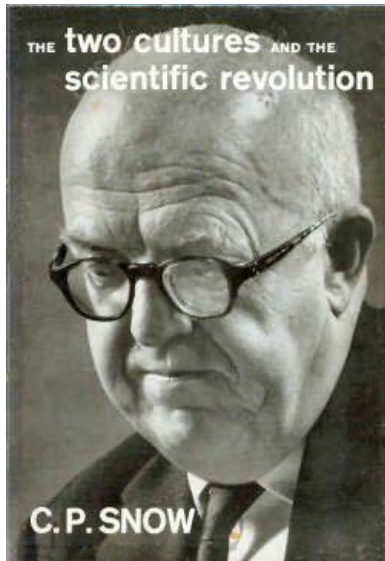

C.P. Snow's celebrated book, based on 1959 lectures, demonstrates that scientific and economic progress requires the scientist to access the creative irony that is the distinction of the Classical artist—and vice versa.

tion of the infinitesimal, which Nicholas of Cusa discovered in recognizing the intellectually fatal error in Archimedes' use of quadrature in defining the generation of the circle *as if ontologically*. It was Kepler's notion of the functional role of the *ontologically infinitesimal*⁴⁷ which prompted Kepler to demand of "future mathematicians," the development of a suitable calculus to represent this. It was Kepler's prompting which gave us Leibniz's unique discovery of such a calculus, and which led to the discovery of the universal principle of physical least action.

This quality of action, is called creativity; it is the function of the *ontologically infinitesimal*, which is the functional distinction of the human mind from the qualities of all forms of animal life as such, including the higher apes. This is also the essential, primary root of not only physical scientific progress in economy, but is a specific distinction of what is properly identified as Classical artistic composition and performance. This is recognized as the function of irony in Classical poetry and drama, as William Empson's *Seven Types of Ambiguity* affords one an overview of that domain in poetry and drama. It is the lurking issue behind C.P. Snow's celebrated *Two Cultures*.

This is key to an understanding the underlying *systemic* causes, fairly described as systemically psychopathic mass behavior, for the presently onrushing general breakdown-crisis of the world's present monetary-financial system. By "systemically," we should also understand "dynamically." This is the key to the conflict over the fate of mankind, between the Olympian Zeus and Prometheus of Aeschylus' Prometheus Trilogy. Creativity is the principle of human freedom. Creativity is what sets human beings apart from beasts in functional terms. Creativity, so defined, is key to understanding the principles of dynamics which underlie all competent policy-shaping of economies.

47. I.e., rather than a merely algebraic infinitesimal.

2.30 A Dynamic View of Euclid

By this point in the report, the reader should have recognized that the intention of most of what I am including in my writing here is intended to provoke the reader to discover what are usually the hidden assumptions of any among today's political leaders' or ordinary citizens' beliefs, the kinds of underlying assumptions from which most great tragedies of the believing leadership and popular constituencies of nations before, and also the presently looming tragedy of our own, have been born. It is essential, that the citizen not be satisfied to know his, or her own expressed opinion; he or she must explore the deeper, usually ignored recesses of his or her mind, to discover what is usually the hidden little devil which is pulling the strings which are controlling what most citizens, including most from our current crop of political leaders, imagines that he or she thinks.

It might be said, that the marionette performing on stage, will tend to point toward his own chest, to be seen to shout defiantly to the snickering audience, "I speak here and now as an independent thinker!"

Therefore, for such reasons, the case of the types of beliefs which are associated, academically, with the assumptions and methods of Euclid, is one of the best choices of subjects to attack, if we are seriously concerned to rescue our republic from the terrible disaster which present popular, as much as official opinion and policy, are bringing down upon our nation just now.

Euclid's Elements is a Sophist's commentary on what had been chiefly the earlier discoveries of the Pythagoreans, the circles of Plato, and others. That aspect of the commentary which should be treated as probably specific to Euclid, is essentially dependent on the presumptions inhering in a specific view of the act of seeing, as being sense-certainty. The commentary takes the elaborated form of expression of assuming that the line of sight, as extended by "drawing straight lines," and by the related mechanisms of quadrature for curved lines, to the notion of the point, line, surface, and solid, is the form of the universe. This lame-brained presumption peddled to the credulous, is supplemented by a number theory based on the notion of the series of counting numbers.

The further elaboration provided by *Euclid's Elements* itself, is unnecessary here, except to distinguish the Euclidean's Delphic mis-use of what Euclid had copied as theorem-topics from the work of earlier writers. Beyond that, closer-knit treatments of the subject of the internal features of Euclid's work itself, have been supplied by available other sources to a degree, that it would be irrelevant to recast those in terms of reference other than what I have included in this present writing. Here, I have started, implicitly, in fact, from Riemann's 1854 habilitation dissertation, in which all earlier treatments of geometry by those notable authors, "from Euclid through Legendre" considered from earlier times, are to be simply cast aside insofar as they reflect any among the "definitions, axioms, and postulates" of what is regarded as

Euclid's Elements and its specific derivatives.

All of the argument which is needed up to that point of matters considered, has been covered, implicitly but essentially, in Riemann's 1854 *Habilitationschrift*.

The essential relevant feature of Riemann's work from 1854 on, is the knowledge, that the actually existing, knowable principles of which the universe is composed, are, with one crucial point of qualification, universal physical principles, comparable to Johannes Kepler's uniquely original discovery of universal gravitation. The grounding of this work by Kepler in, chiefly, the work of Nicholas of Cusa and Cusa's relevant followers, such as Luca Pacioli and Leonardo da Vinci, and the discoveries of Kepler himself, represent the unleashing of a process of self-development of physical science leading into Riemann and beyond.

Riemann's own work, which proceeds in essentials from the work of Kepler and Leibniz, and from a unique contribution by Lejeune Dirichlet, defines a general way of exploring the universe experimentally, to such a degree of relative excellence, that known net progress of science beyond that point can be folded into foundations provided as the outcome of Riemann's own contributions.⁴⁸

This view of Riemann's place in the scheme of things, provides the preconditions for a recasting of the notion of the way in which real-world economies came into existence, and were developed.

However, the heart of this achievement by modern economy, remains that development of the notion of physical economy which was introduced by Gottfried Leibniz, as, then, developed further by Leibniz himself, from what I have already referenced earlier, here, as the explicit standpoint of Leibniz's revival of the Classical Pythagorean-Plato concept of the principle of *dynamics*.

Leibniz thus provided the basis for the notion of the functional existence of *physical economy*. Leibniz's work had significant influence in shaping the economic thinking and practice of the patriotic leaders associated with Benjamin Franklin. For various reasons among shifting circumstances, Alexander Hamilton and such among his followers as Mathew Carey and Henry C. Carey, together with Frederick List, became the leading spokesmen for the early-Nineteenth-Century development and application of Hamilton's American System of political-economy to the challenges of internal development of the U.S. economy, and related matters of foreign relations,

48. To keep the political accounting straight, it should be restated in this place, that the progress of physical science during and since the lifetime of Leibniz, into the Nineteenth Century, was situated within the post-1648 context of the role of Cardinal Mazarin in the Treaty of Westphalia and of Mazarin's associate Jean-Baptiste Colbert in the establishment of modern physical science as the practice of dynamic modes of development of the *physical economies* of the modern, post-Westphalian quality of nation-state. Leibniz and his principal collaborators worked from within that post-Westphalian context, relying chiefly in the legacy of Nicholas of Cusa, and the proximate impact of the radiated work of Kepler.

from the founding of our republic through the time of the great reforms, under President Franklin Roosevelt, that patriotic tradition which enabled us to rise from the ruins bestowed by the successive Presidencies of Coolidge and Hoover, to become, by 1945, the most powerful economy the world had ever known.

There are leading, most crucial aspects to the American System, which distinguish our American System from its principal historic, continuing rival and frequent adversary, the Anglo-Dutch Liberal system associated with the continuation of the British Empire from the time of Britain's founding as an empire-in-fact of the British East India Company, circa February 1763, to its presently extended, Anglo-Dutch Liberalism's neo-*ultramontane*, so-called "commonwealth" form of empire, as the presently reigning world system known as the currently self-disintegrating form of the post-August 1971 floating-exchange-rate, monetarist system.

2.31 Riemannian Dynamics

Albert Einstein's retrospective view of the uniqueness of the relationship of the process of development of modern science from Kepler through Riemann, is no exaggeration respecting either what that characterization properly includes, or what it implicitly excludes. The correlated argument is that made by Academician V.I. Vernadsky, in defining the universe including what may be termed the *rigorously crucial-experimental*, or which is, in Riemannian style, a *unique-experimental* quality of discovery of two qualitatively distinct general phase-spaces called, respectively, by Vernadsky, as the *Biosphere* and *Noösphere*. Vernadsky's Riemannian definition is not implicitly, or otherwise excluded by Einstein's known utterances on Kepler and Riemann, but it adds crucially important aspects bearing on the implications of the human individual mind's existence within the universe as a whole.

Compare this with Einstein's specific formulation on this matter, that Kepler-Riemann physical space-time represents a universe which is "finite, but unbounded." It were better said, for pedagogical purposes, as will be made clear, once more, in this location, that the universe is *self-bounded*. Einstein would have agreed implicitly.

The immediately obvious reaction against the expression "self-bounded," is that this flies against the naive prejudices expressed by, for example, the Euclidean, or Cartesian notion of *space* (and, also, *time*). The question is posed, therefore, as:

is the universe Euclidean in the sense of purely arbitrary forms of *a priori* assumptions concerning vision; or, in the alternative, do we exclude any image of the universe within which we act, and which acts upon us, whose existence is not defined by the kind of experimental knowledge which shows us what we can, or can not do by exertion of our will? This exertion of the will lies within whatever that universe actually is,

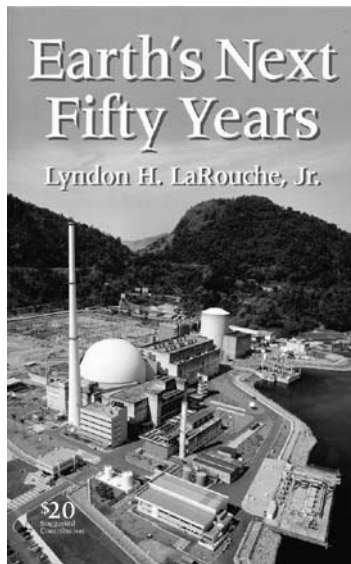

Academician V.I. Vernadsky's (1863-1945) argument in defining the universe in terms of qualitatively distinct phase spaces, is Riemannian in conception, LaRouche writes, and bears crucially on the implications of the human mind's existence within the universe as a whole. LaRouche's own 2005 book, shown here, develops Vernadsky's ideas from the standpoint of a program for global development.

apart from those temptations of sense-certainty which mistakenly define knowledge of the universe aprioristically, by the merely perceptual act of *seeing as such*.

If the universe is a universe, then it is either *self-subsisting*, or it does not exist. Shall we, then, define the universe by arbitrary contemplation of the temptations of the sundry faculties of vision, or of hearing, or of touch, or of smell, perhaps? Or, in the alternative, through experience of the efficient action and reaction to our efficient existence by the universe? Once we have rejected what we must recognize as the practically, baseless, aprioristic presumptions respecting the instrument of vision, as by such as a Euclid or a Descartes: It is not bare, abstract existence, but the *anti-entropic* development of mankind's power to exist, which becomes the agency by which the universe speaks to us of scientific matters, and which so serves as our certainty of the existence of that universe as a universe. Then, as the best modern physical chemistry insists, space, time, and matter have no respectively independent existence, but only matter-space-time remains as a useful definition of the setting of our existence.

On this account, there exists no known, competent evidence in physical science which contradicts the argument respecting man and woman, in *Genesis* 1, that man and woman are made in the likeness of the Creator of the universe, including the matter of the power of will, or that of the Apostle Paul's *I Corinthians* 13: we see our experience, our existence as if in a darkened mirror. However, we are permitted to bring a bit of

light into the situation, if we work hard enough, and also long enough, to gain some increase in our knowledge. The general conclusion to which this leads, is a general obligation to spend our lives doing what is good in this universe, for this universe. Faith becomes a mission of a mortal existence which locates its own immortal identity within a universe which is, ontologically, a moment of a simultaneity of eternity within the universe of an always efficiently willful and thinking personality of a Creator, in a universe which is, as experimental evidence shows, inherently *anti-entropic*.

There could be nothing known in competent science which could actually contradict what the individual human mind might be enabled, essentially, to recognize, as if in a darkened mirror, provided we concede that it is a darkened mirror from the vantage-point of our mind's eye. A happy individual person, as Leibniz defines happiness, is, on principle, one who is able to bring a bit more light to illuminate his or her own, and his or her society's practice, and his or her society's

duty on this account.

That much said respecting those implications, we accept *that* universe as *the universe*. Scientific progress rewards the society which sees the universe, if more or less clearly, in those terms. This will be reflected, implicitly, by what I have to report here on the subject of both a science of physical economy, and on the subjects of those ideas and uses of money which are, or are not in accord with the goals specified in terms of physical economy. As Paul writes in *I Corinthians* 13, truth is expressed as *agapē*, as the Apostles John and Paul define this *ecumenical* quality.⁴⁹ That much said, we may now return the dialogue, so to speak, to the ecumenical fraternity of the world's working laboratories.

What Is a Universal Principle?

The term "universal principle" is properly used only when it identifies an experimentally validated principle which pervades, and, in that sense, encloses the universe: the entire universe.

The qualified exception, which is not much of an exception, may be the discovered principle which has been validated as universal by the standard for a unique experiment; but, what is discovered may express a relatively universal sub-universe, a phase-space. Prime examples of that kind of qualification are Vernadsky's experimentally premised definition of the *Biosphere*, and also the general definition of proof which I

49. It were sufficient to add, that I abhor the readings of the Bible which treat it as it were to be read as a "a dime novel."

have already indicated here, above, and in earlier locations for the *Noösphere*.⁵⁰

Among those three phase-spaces, all occupy the same universe, in the fashion in which human mental life, absent in the animals, appears as a phase-space of the living domain, but both human and other life occupy an efficiently shared domain of life, which operates efficiently, and is acting upon the domain of non-living processes. In addition, life acts reciprocally upon the domain of human cognitive powers, and so forth. These three are not hermetically separate spaces, relative to function, but are phase-spaces within the universe's function as a totality.⁵¹

In physical economy, for example, it is those creative powers of the individual human mind associated with the means by which the human mind generates, or replicates either a discovery of a universal physical principle, or a modification of the application of that principle as such, which is the essential marker of cognitive activity. This includes discoveries respecting the principle of life itself. It is the processes of discovery of such principles, of amplification of the categories of application and range of application of such discovered principles, which are the core subject of creativity.

To make the image of the crucial idea here clear, consider the illustrative example of the established Keplerian image of our Solar system:

Begin with an amusing ambiguity: The Solar system started its career as a *solitary*, fast-spinning Sun. Under such conditions, it shed some of its mass, which was assembled in the space around the young Sun, where it condensed into a polarized plasma lying in the implied planar sheet into which the planetary material assembled around the Sun would be dispersed. It has been calculated by a leading relevant institution about two-



Rembrandt's "Self-Portrait as St. Paul." The Apostle Paul wrote to the Corinthians that we see our experience as if "through a glass darkly." However, LaRouche notes, a happy person, is "one who is able to bring a bit more light to illuminate his or her own, and his or her society's practice." Rembrandt was certainly such a person, whose unique use of light in his paintings conveys true enlightenment.

50. I allude, once more, to my "Vernadsky & Dirichlet's Principle," *EIR*, June 3, 2005.

51. To reach conclusions on such matters, it is essential to avoid the methodologically incompetent, but usually preferred choice of pathway, of attempting to adduce the principle of cognition from the physics of the inanimate, or the functions of the human mind from biology as such. Rather, the distinctly phase-spatial powers of the mind which do not exist in lower forms of life, must be the platform from which we observe, and understand the nature of living processes.

and-a-half decades ago, that were the radiation from the Sun polarized, it were likely, from the standpoint of what the development of "The H-Bomb" indicates, that the Sun's actions could have thus produced the celebrated 92-element basic Periodic Table out of the plasma expelled from the body of the Sun itself.

Then, according to Carl F. Gauss, the material dispersed, by something like fractional distillation, from the Sun, into the future planetary orbits, but, for lawful reasons, were "condensed" in the forms of planets and, sometimes, moons.

The purpose of this element of implied dialogue here, is to emphasize that the notion of universal entropy, as traced from Clausius, Grassmann, and Kelvin, was always an arbitrary insertion. The universe is growing qualitatively, creating new states within itself. The very existence of cognitive man on this planet is a demonstration of the point that the laws of the uni-

FIGURE 7

Quadrature of the Circle

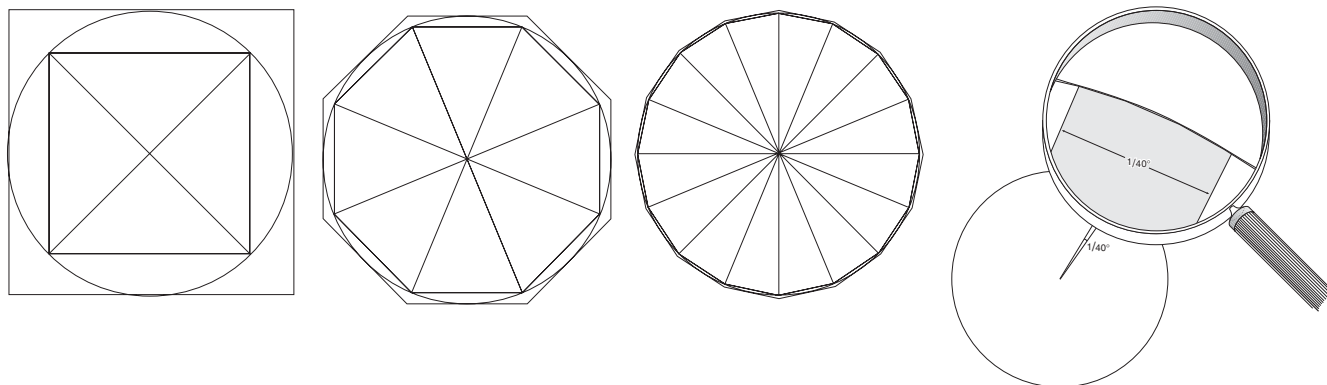

Nicholas of Cusa showed that Archimedes' attempt at "quadrature of the circle"—to approximate the value of pi—was ontologically incompetent. The first three drawings show the process of estimating the area of a square approximately equal to that of a given circle, as the average area of two regular polygons. In the last drawing, although the inscribed polygon of 216 may seem to closely approximate a circle in area, it actually contains a devastating paradox. There are slightly more than 182 angles of the inscribed polygon within each degree of circular arc.

verse include the provision that the universe in any state has the potential for generating a relatively higher state.

Therefore, whence the Clausius-Kelvin system's spinning of a so-called "Second Law of Thermodynamics"? Actually, the immediate source of the doctrine was a certain kind of mathematics, the kind we might associate with Clausius's crony Grassmann. The fallacy is the same, in the sense of "hereditary" consequences in mathematical science, as the notions of those whom Carl F. Gauss exposed for their shared incompetence in method in his 1799 doctoral dissertation on the subject of what is classed as the Fundamental Theorem of Algebra. If one interprets experimental evidence with the kind of mathematics which Gauss exposed as incompetent for the cases of D'Alembert, Euler, Lagrange, et al., then that mathematical method itself will tend to produce something akin to a reductionist's "Second Law" from even valid experimental results. This is what is often referred to as the "hereditary principle" in logic and mathematics.

In the case of Euler, for example, we have Euler's denial of the Leibniz infinitesimal, a denial based explicitly on the exact same reductionist "logic" to be encountered in Grassmann's mathematics. Grassmann's attack on a Riemann work on electrodynamics reflects the same incompetence induced by the relevant "hereditary" principle commonplace to reductionist formalism. In this case, Grassmann et al. were employing a clear fallacy of composition of the experimental evidence to draw a conclusion which is not justifiable in the real world. So, Grassmann et al. denied the implications of Wilhelm Weber's discovery of a principle of electrodynamics, which stands, in fact, proven by a standard laboratory experiment to the present day. Riemann had participated in the relevant experimental work of Weber.

The issue here is a matter of the same error which Nicho-

las of Cusa had exposed in the work of Archimedes on the quadrature of the circle: the error of making a "hand-waving" gesture, to fend off legitimate criticism of presented claims to either discovery or non-discovery of a principle. Translating Cusa's argument into the language used by Leibniz et al., we call it the principle of action presented in the dynamics of the planetary orbits as a motive form of action corresponding to the notion of any smallest change in direction as being infinitesimal; it is a kind of smallness which does not belong to an hypothetical dot, but to a continuous causal form of action, continuing change, which must therefore appear to the observer as if it were an infinitesimal.

Therefore, if we eliminate consideration of the experimentally demonstrable efficiency of what might appear experimentally to be an infinitesimal, what happens to our idea of the nature of the universe? The eliminated consideration may be the evidence of a lawful principle of action by the universe! In fact, that is precisely the case; that is the issue.

More significantly than that: What shall we say of the mind which rejects the existence of an infinitesimal, such as Kepler's principle of the orbital expression of gravitation? Here, once more, what is termed "the hereditary principle" of mathematical practice applies. The rejection leads to the kind of conclusion associated with Isaac Newton: that the universe is always running down, entropically, such that the Creator must wind the universe up again, from time to time.

How Dynamics Works

Now, we have reached a crucial point in this entire report: the subject of the role of the principle of dynamics in social and other behavior within our Riemannian universe.

The method employed by the followers of Paolo Sarpi, such as his house lackey Galileo, and René Descartes, is the

famous, and also abundantly failed method of forecasting employed by virtually all of economics' relevant failed forecasters, and the like, still today. They assume a universe composed of discrete particles, and project an assumed trend of movement of those particles to a future point, or even to hypothetical, Euclidean "infinity."

That method is never really successful except to those sufficiently gullible to wish, more or less desperately, to believe in it. The relevant point of the argument most simply, is that the human will is capable of changing its proverbial mind, such that well predicted developments do not happen, and developments which it were said could never happen, often do. This poses an implied question: given, that predictions are never really trustworthy, especially if they involve statistical projections, what is trustworthy? For the kind of question, the failure of the typical statistical forecaster implies, there is no satisfactory answer. It is essential to adopt an entirely different approach, an approach which Leibniz named "dynamics." Some would like to think of it as "The appointment in Samara" principle. Think back to my remarks here earlier on the subject of Classical notions of tragedy.

In typical human tragedy, a society is operating on certain assumptions to which it responds as a student of geometry might respond to a learned axiom or postulate. The destiny of that society is determined, not by what the individual leading members of society think, but what the axiomatic assumption they share as belief, compels them to do, even if they destroy themselves, not in their imagination, but in real life, if they do. These days I often think of the recent months' mass behavior of the U.S. Congress ("go along to get along") and the current collection of leading Presidential pre-candidates, in this connection: *speeding up in the effort to reach nowhere faster and quicker than the rivals.*

The universe, and society function on the basis of the controlling role of assumptions tantamount to universal principles. So, in real-life economics, we are dealing with a conflict between two, mutually interacting universes. On the one side, we have the real universe, of which our typical political leaders today have no significant knowledge, especially in matters of economy. On the other side, we have the set of false assumptions in which they currently place an axiomatic quality of confidence, assumptions sometimes presented under the label of "rules of the game we play." Hence, tragedy!

Everything of importance to mankind is subject to one or another expression of a dualism of that sort: the principles of the real universe in which society is acting, versus the assumed principles under whose influence the society intends to act.

How, then, to break out of the kind of tragic mode which that kind of dichotomy implies? The subject is my specialty. I do not know all the answers, but, I have the considerable advantage of knowing that some of the most important questions exist. I know, most importantly, that we must always attune our selection of crucial choices in life to the matter of the ultimate outcome for mankind, for our republic, for our im-

mediate mission, and, finally with regard to what the outcome of our having lived will be for the mankind amid which we live. Most people, even gifted and otherwise intelligent people, usually think in exactly the opposite direction, much more so among the Baby-Boomer strata, than among my dwindling generation. I think in the relatively long-term, as regard for principle requires; I live in a society, in which the opposite is usually true, especially in these times when Sophistry reigns as if from above. It is principles which determine the future, and it is fools who live by attempts to merely predict from perceived facts evidently at hand.

This error is what Paolo Sarpi's reform has contributed to the degradation of modern European culture, in particular. The elimination of consideration of true principle, in favor of expediency, as the citation from Adam Smith's 1759 *The Theory of the Moral Sentiments* proposes, has virtually destroyed the ability of the Liberals and their admirers to know what a principle is.

Remember this: the source of action in this universe, is not the percussive interaction among loose parts, but the force of dynamics which flows from discoverable universal principles. Thus, in real politics of nations, and a world of nations, the secret of success of societies is their reliance on principles, not little things, first and foremost, and to deal with matters of the small and the short-term from the standpoint of principles. Principles can be trusted; statistics can not.

Thus, what I have presented here throughout this report as a whole, is the matter of principle. It is the only guide we can really trust, when, as now, everything in the world we have known for about four decades is turning upside-down.

3. An Ecumenical Order

If a successful recovery from the world's present economic and related crises is to occur, this must be premised upon a system under which virtually the entire territory and future of our planet is occupied by a system of respectively sovereign nation-states: *an ecumenical community of respectively sovereign peoples and their nations.* This system, which will be, in fact, a contemporary affirmation of the anti-imperialist principles of the great Treaty of Westphalia, would also be an echo of what had been the expressed intention of President Franklin Roosevelt for the post-war world, had he not died at the time he did.

His death has been, for all our patriots, the unleashing of those devils among us which have sought, since the moment of his death, to ruin what he had intended to be the culmination of his life's work. We must rue this loss, not only for reason of the benefit he had given to our own republic, but the benefit our great President Franklin Roosevelt had intended for our republic's post-war role, on behalf of all mankind.

That intention is not stated here as merely a broad generalization from what is, in and of itself, a noble principle of a

true civilization; but, is premised upon a precise characterization of the specific quality of post-July 25th,⁵² currently skyrocketing, world-crisis of both finance and physical economy, which has carried the present world at large to the verge of not only a collapse of the monetary-financial and related systems of such locations as North America and western and central Europe. The collapse which has occurred, just now, has been only the beginning of what threatens to become quickly a generalized, chain-reaction form of breakdown of the world financial system and associated economy at large.

So, at the present juncture, at the present moment, when the currently extant world monetary-financial system, especially that of the recent thirty-six years, is already doomed, and that hopelessly so, it is appropriate and necessary to restate, very briefly, a point presented here earlier:

The demise of that system is onrushing, now. The crisis of the Americas and western and central Europe which has now entered into its terminal, proverbial “countdown” phase, has set off a global chain-reaction. If we do not act now to prevent early specific consequences of that recent turn toward the worst, that crisis has the relatively immediate potential for a global effect which is roughly comparable in numerous ways to what happened inside Europe following the mid-Fourteenth-Century collapse of the Lombard banking House of Bardi. The only concern of people who are still capable of reacting sanely to the present crisis under these conditions, is: *how to dump the present world monetary-financial system, and quickly replace it with an echo of the original Bretton Woods system, all in a way which saves the function of, and promotes the resumed growth of the physical economy of each and all of the nations of the planet.*

The rescue could be accomplished. The remainder of the present chapter of this report shows, briefly, how and why. I also point out some typically leading dangers which we must be alert to avoid.

3.10 The Economic Action To Be Taken

So, an elementary remedy exists, potentially, provided the right combination of powerful nations of the world now proceeds, quickly, to make it happen. Those sponsoring nations must cooperate to the effect of playing a leading role in establishing a new world system, based on a network of treaty-agreements, which, in effect, replaces the cancerously rotted-out International Monetary System (IMF) of today, by a profoundly reorganized IMF, thus crafting one which echoes the original intentions of U.S. President Franklin D. Roosevelt for a global, fixed-exchange-rate system.

52. The scheduling of my July 25, 2007 webcast, “The End of the Post-FDR Era,” was based on picking an opportunity in its Washington, D.C. site for the new phase of global financial crisis which I had known would erupt during either late July or early August. This present document was intended to serve as a Democratic Party’s 2008 campaign’s prolegomena to be uttered during the period preceding the scheduled return of the members to the Congress.

3.11 This means a new world credit system, rather than a monetarist system, a new system in which nests of long-range treaty-agreements among sovereign states prevail, which are freed of the kinds of pro-monetarist central banking complexes which have dominated the recent decades in world affairs.

I propose that a powerful initiating group of nations, the U.S.A., Russia, China, and India, should join to assemble as a core around which to quickly rally other sovereign states, to put the world’s present monetary-financial system into reorganization-in-bankruptcy, and also put a set of virtually bankrupt national central banking systems, such as the U.S. Federal Reserve System, into a state of receivership, by the relevant sovereigns, for reorganization in bankruptcy by relevant governments.

3.12 Under such an initiative, the physical, social, and economic stability of each and all of the cooperating sovereign states, will depend on conducting the reorganization in a manner which *ensures the continuation, and also accelerating growth of all employment in physical production of goods and in traditionally pre-1971 forms of essential professional and related services.*

3.13 Financial debt attributable to financial and related forms of speculation, which have the underlying character of gambling debts, must be either summarily nullified, or reorganized in a way which is suited to bring about that beneficial result.

3.14 The creation of a new international system *will eradicate present, hopelessly ruined monetarist systems, and replace them, as the intention of the formation of the Bretton Woods System shows the pathway, with an American System-style new monetary order in the world, under which the government monopoly in sovereign utterance of credit, as a monopoly of the respective sovereign nations,* replaces all so-called central banking systems. This is complemented by the establishment of so-called protectionist systems, with what were formerly employed under the name of “fair trade,” rather than as “free trade” systems.

3.15 Although the generation of credit, through *the sovereign nation-state’s monopoly on the utterance of its lawful currency, will be applicable to many good purposes,* the primary use of the expansion of the actual or implied money-supply shall be medium- to long-term formation of physical capital, of which it must be expected that no less than about half of that investment will enter circulation as investment in the development of essential basic economic infrastructure.

3.16 This ratio of infrastructure to the remainder of the economy can be achieved and sustained, provided there is *a proper*

FIGURE 8
Table of Organization for U.S. Economic Recovery

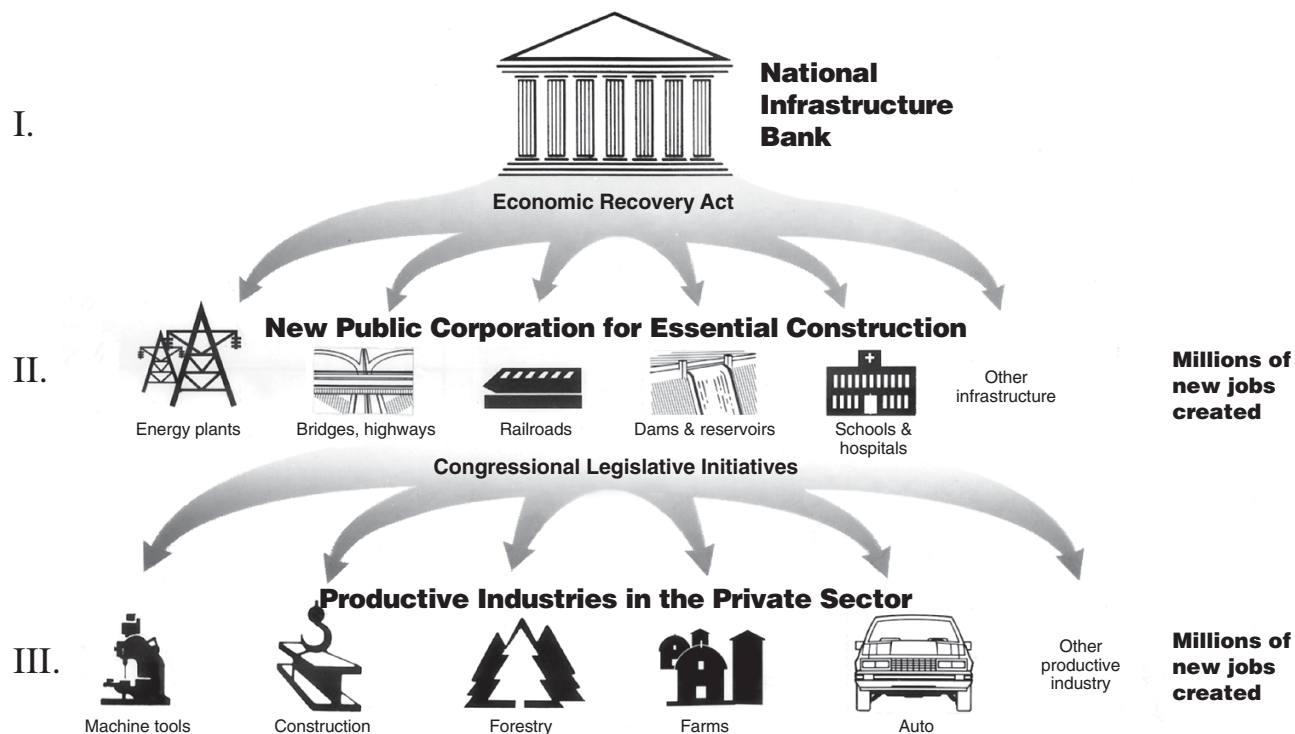

Prepared August 2007

This graphic is part of a programmatic document being circulated by the LaRouche Political Action Committee, along with LaRouche's proposed "Economic Recovery Act of 2007." The document calls for the creation of a National Infrastructure Bank, to provide low-interest, long-term credit for infrastructure projects in the public interest. A similar approach will be required internationally.

emphasis on science-driven scientific and technological progress. The recovery will be slower during the first decade of such a program, and a bit better in the second. Therefore, a long-term scheduling of repayments of capital is needed, as each case will indicate.

3.17 *At the outset, the world will be gripped by a situation in which only meager supplies of private investment credit will be available.* Most private financial capital is presently either vanishing from the market, or will have vanished early in the onset of the crisis-conditions produced, and reorganizations in bankruptcy required by the presently accelerating, chain-reaction failure of the world's principal existing monetary-financial systems.

Therefore, *state credit, at interest rates below two percent simple interest per annum, for long-term investments in public infrastructure, will be the principal source of, and driver for long-term capital formation, that chiefly in basic economic infrastructure.* The investment in infrastructure will also serve as the driver for the recovery and growth of the private sector, and through construction and related investments in the public sector which will create the

growing market for the products of the private sector.

3.18 This requires *a strictly managed set of sovereign nation-state economies bound together by a fixed-exchange-rate system.* Such a system will be managed, chiefly, through treaty agreements among partners in the credit and in tariffs of the system.

For example, as I proposed legislation to this effect during 2005 and beyond, I intended then, that the Federal government should "capture" the relevant idled potential of the U.S. automobile-manufacturing sector, using the machine-tool capabilities which have been inherently embedded in the capacity of the automotive sector since war production of the 1939-1945 interval, for supplying the needs of physical capital improvements and expansion in the public sector of the Federal, State, and local governments. The market for such products was implicitly vast and long-term in nature, and remains so today. Now, we must recapture that potential which was lost through a failure of the U.S. Congress during 2006; however, much of the lost capability could still be regrouped, and could thus re-energize localities in the U.S. which have been ruined as a result of the Congress's failure to act as required.



USACE/Fred-Otto Egeler

Construction of the Seven Oaks Dam, the tenth-largest earth-filled dam built by the U.S. Army Corps of Engineers, in Highland, Calif. Completed in 2000, it now protects 3.5 million residents from flooding. The work of the Army Corps typifies the link between the public and private sectors in completing large infrastructure projects at the most rapid rate possible.

3.20 Domestic U.S.A. Measures Are Required

Thinking on the necessary global scale, *we must rely heavily, from the start, on the revival of the relatively high culturally-driven skill-levels of North America and western and central Europe, in particular, working toward the point years ahead, when the populations with less developed technologies among the majority of their populations, begin to catch up.*

3.21 We must employ a resumption of so-called protectionist policies of practice, as levers in support of a return to their former roles as export-oriented sources of capital-intensive, science-driven increase of the productive powers of labor in agriculture, industry, the scientific professions, and basic economic infrastructure.

3.22 We must uproot, systematically, the folly of that zeal for the cheapness of labor, the policy which has done the most to ruin us since the folly of the 1964 entry into a long war in Indo-China. That was the war which was born of an official lie, the Gulf of Tonkin resolution signed by most Senators. We must end the follies typified by the red-eyed passion for physically destroying our economy through a policy called “controlled disintegration,” since the Trilateral Commission and related rampages of the 1971-1981 interval. Practices introduced during that ruinous interval, must be superseded by a return to emphasis on increase of the physically productive powers of labor per capita and per square kilometer of the nation’s average territory.

3.30 The Global Social Aspect Described

In the meantime, over the decades since the close of World War II, especially since the successive aftermaths of the assassination of President John F. Kennedy, and the 1971-1972 entry into a global floating-exchange-rate regime, history has moved on, its movements often left unheeded by governments and others. We have thus entered a period marked by the fact that the population of China and India, the indicative cases for assessing the situation of Asia in general, have reached the respective levels of 1.4 and 1.1 billions living individuals. Not only has the mean level of *net* global physical productivity been reduced by the changes during this lapse of time; but, the planet as a whole has been changed, qualitatively, in other respects. The harsh poverty in the great majority of the population of India, and the comparable pressures generated within China, typify the situation throughout Asia, compared with worse condi-

tions in most of sub-Saharan Africa.

The related problems of Asia, Africa, and much of South and Central America, have brought the world as a whole to the state of affairs in which some very radical changes in required standards for economic development, must be made at this juncture.

3.31 To meet this challenge in Asia, Africa, and much of the Americas generally, we must effect certain immediate phase-shifts.

This includes some changes in social standards; but these required improvements depend upon capital-intensive, medium- to long-term investments in both basic economic infrastructure, and in science-and-technology-driven rates of physical productivity per capita and per square kilometer. This will require advances, based upon long-term credit, which will increase the rates of physical productivity, in Asia, for example, over a quarter to half a century, sufficiently, that the beneficiaries of credit uttered for the benefit of this population, must be not only repayable within the course of the capital cycle, but that schedules of issuance of credit, and schedules of repayment must reflect the unavoidable factor of delay built into repayment schedules.

The complementary point is, that “white elephants” should not be given to nations kept at poorer levels of current average performance. Hit-and-run

foreign investment in projects, into poor nations, are a form of virtual mass-murder at the point scheduled repayments come due, especially under conditions defined by a global floating-exchange-rate system. The nation issuing the credit must ensure, that the means for repayment of the advance of capital, is built into the package for the nation as a whole. This requires attention to increasing the level of the productive powers of labor, per capita, and per square kilometer of total territory, that in a degree commensurate with the scale of charges incurred by what is presented as a capital or comparable improvement.

3.40 *The Franklin Roosevelt Paradigm*

In politics, as in science, it is often useful, and sometimes indispensable, to put aside statistics for a while, and concentrate on the idea of the occasion when an isolated incident, or set of incidents, actually reveals the dynamics of the process in the large which those isolated events may be sufficient to actually reveal. In other words, I am speaking of unique events, singularities, as they often appear in physical-scientific processes, but also in social processes.

How, for example, can we, sometimes, recognize the conscience, or lack thereof, in the conduct of several individuals, or even a single individual? What is the effect of crucial social singularities expressed by small groups or even individuals?

So, rightly, notoriously, an observation of a drunken U.S. business executive abroad, or an individual U.S. soldier's actions, as experienced folk will tell you, tends to affect the way in which foreigners look at our nation; and, often, unfortunately, those foreigners have been right. The reflections of U.S. government or economic interests in dealings with matters of the internal economy of a foreign nation, are, all too often, justified reflections of the character of the relevant governmental institution in Washington, D.C.

The performance of international agencies, such as the IMF and World Bank, and others, was often, even usually, very ugly on these accounts, especially after 1971-1972.

Those of us who represent today the rapidly dwindling numbers of veterans of service abroad during World War II, may recall the shocking effect of experiencing the shift in attitudes toward local nations and their populations after President Franklin Roosevelt had died. The shift, as I observed some of it, in and around what was still named Calcutta, India, then, was indicative for me. Americans, unlike the Brits, generally liked the Indians, and were sympathetic to the cause of their national freedom, as I witnessed a test of this during the period of the so-called "Calcutta riots" of Spring 1946, which erupted as a response to a quickly paced series of monstrously brutish provocations, by British police, including one terrible one of massed direct machine-



www.kolkataweb.com

During the Calcutta, India riots of Spring 1946, LaRouche observed the "brutish provocations" of the British, in their determination to prevent the decolonization efforts that FDR had promoted. Here, dead and wounded on Aug. 16, 1946: some 3-4,000 people died when British troops fired on protesters.

gun fire, head-on, near the head of the intersection proximate to the Maidan, into a demonstration.⁵³

As the Truman Administration nearly always sympathized with British colonial interests in ways directly contrary to the policies of President Franklin Roosevelt, the U.S. became complicit in the London-directed reconquest of Indo-China (initially, by releasing and rearming captive Japan prisoners of war within that country). There was, similarly, Dutch reconquest of Indonesia, and the British psychological-warfare role in the successive creation and suppression of the Mau-Mau uprising in Kenya. The attitudes among Americans shifted, brutishly, in a way which reflected the replacement of Roosevelt by Truman. The singularities expressed as instances of ugly practices of nominally U.S. interests abroad, in Africa, Asia, and South and Central America, came as a reflection of the shift of official U.S. loyalties in a way congruent with the shift from Roosevelt to Truman.

Do you, today, recognize the depth of the poverty-driven despair of the all too typical poor Arab, for example? Do you recognize that in a life lived in such extremely desperate conditions, generation after generation, that one does not sense a loss of identity in a suicidal attack on an image of the oppressor? Do you understand the degree of desperation which im-

53. As I witnessed crucial features of the relevant interval, which included events proceeding from the incident of a murderous lathi charge against an essentially routine student-led demonstration at the Governor's palace-site, through the machine-gun massacre at Daramtala, and several nights of millions of Bengalis marching, with rhythmic shouts throughout the night, of Hindu and Moslem patriots together, day after day until exhaustion, more than anything else, left the exhausted streets, to mark the want of a constructive outcome at that juncture.



www.rafahtoday.org



UNICEF

“Do you understand the degree of desperation which impels a suicide-bomber recruited from among the ranks of otherwise normal, but desperately poor Arabs suffering within a politically hopeless situation?” Left: This boy’s home, in Rafah, Gaza Strip, was destroyed by Israeli bulldozers. Right: A young casualty of war in Iraq.

pels a suicide-bomber recruited from among the ranks of otherwise normal, but desperately poor Arabs suffering within a politically hopeless situation?

Such facts considered: do you wish to “stamp out” terrorism among the desperate, or, do you realize that it is necessary to stamp out the desperation? Do you think you can stamp out, by mere military force, the hatred which the circumstances of long war foster? Are you willing, on Vice-President Cheney’s mere whim, to send U.S. soldiers to die futilely in Southwest Asia, where they will be overwhelmed by the forces of asymmetric conflict represented by millions who are willing to die to ruin the U.S. forces as much as possible? Do you then call yourself a “strategist,” an expert in counterintelligence? Did you ever read the account of the Peloponnesian War, or perhaps the resistance against the Spanish by the Netherlands, or the 1618-1648 Thirty Years War, or study the documented resistance by the people of the Soviet Union to the Nazi onslaught? Do you still wish to call the authors, or political supporters of the ongoing warfare in Southwest Asia “strategists”!?

There is an ugly world of people driven to desperation brewing out there, and we, with our Anglo-Dutch Liberal partners, have joined forces to contribute more than anyone else to producing *this condition of peril to us* worldwide.

Now, look at yourself. Now, think back to the conditions of religious warfare, over thirty years, 1618-1648. How do

you stack up, emotionally, intellectually, when you put yourself and your attitudes beside the religious warrior of the middle of the 1618-1648 interval? Do you recognize yourself as not merely typical, not merely a statistic, but as an actual singularity with your own, radiating effect on the process in which you and your actions and attitudes are situated?

Ask yourself, how was that terrible warfare of 1618-1648 finally ended? It was the Peace of Westphalia, prompted by the intervention of Cardinal Mazarin, who was crucial in the single principle of agreement which brought together the parties which had been warring like feral beasts against one another over thirty years. Mazarin and others crafted a remedy, not only to make a peace which has not prevented all wars since, but set a moral standard for statecraft which has been the instrument of policy which has done the most to create sufficient peace in Europe to allow European nations to arise from the rubble of religious warfare raging back and forth across Europe from 1492 through 1648.

What was the principle?

There was a single principle: the commitment of each to devote himself to the benefit of the other.

It is time to heal the wounds of long war, through the renewed commitment to that principle of statecraft, the Westphalian principle, which marks the dividing-line between decent human behavior and bestiality of man to man.

3.41 Now, of late, as throughout leading circles in Europe, circles typified by Vice-President Dick Cheney and his crew in the U.S.A. such as Samuel P. Huntington, with his *The Soldier and The State* and *The Clash of Civilizations*, have moved to institute a policy which was known as Fabian agent Alexander Helphand's "permanent war, permanent revolution" and which, combined with Cheney's and Bush's adoption of the doctrine of religious hatred, have been revived as the official policy of the George W. Bush, Jr. Administration, as its policy today. These are echoes of the same military and related policies practiced by the Roman Empire, and under the policies of practice of the religious warriors of Venice's Crusaders and of the 1492-1648 interval.

Both the American soldier and the good will of other peoples and nations, have been sacrificed on the altar of Vice-President Cheney's and Prime Minister Tony Blair's Fabian war-criminality, a criminality which the unsettled mind of President George W. Bush, Jr. bears like an emblem around his neck, a guilt which has been adopted as the strategic policy of the present U.S. Administration, a policy to which a sheepish leadership within the U.S. Congress has capitulated with little more resistance than merely a few occasional whimpers of bad conscience.

Could people who continue to support such wretched policies rightly call themselves *patriots*? Patriots of *what*?

3.42 Two War Stories

As described to me, decades past, by a late friend, he a veteran senior officer who had commanded an armored unit spearheading Patton's Third Army charge through southern Germany, and who occupied a high position in a department of government during the post-war period, a relevant situation in the closing phase of war in Germany was, summarily, the following.

When his unit took a town, they looked up the mayor and other relevant German civilians from the locality, and installed them in their useful positions. The idea was to consolidate the line of march of the U.S. troops, by enlisting local civilian officials and relevant technicians not obvious Nazis into reassembling the essential logistics needed to support the inhabitants of that locality, to maintain the continuity and function of the conquered nation, case after case, along the line of march. As President Eisenhower might have indicated, this was not all the doing of Patton himself, of course, President Nixon's opinion notwithstanding. This was standard good military tradition of U.S. practice, like a soldier's chocolate pieces to children of the nation which we had invaded, whether Italy, France, or Germany. One might describe the desired rule of warfare: "Fraternization: no; building bridges to the future: yes."

That is the fruit of the Peace of Westphalia. Love your enemy, by showing him, or her, that you are committed to his, or her just best interest first, even if that is done at the risk of merely piling up some treasures only in Heaven. The object of

warfare, when that were necessary, is to win the peace, as quickly as feasible, and stop the fighting, and begin the rebuilding, right there.

There was a point in the recent U.S. invasion of Iraq, where that had been possible. When the surrender had occurred, was the time to accept the surrender proffered by relevant Iraq military and qualified civilian authorities, by turning the administration of the country back to its qualified, and recognized representatives. Potentially, at the moment that that creative action, consistent with our traditional practice, had been on the table, the Bush Administration sent in a dubious figure generally regarded as a George Shultz protégé, Paul Bremer, and with Bremer's arrival, a war which had just been won by U.S. military forces, was suddenly lost. It was, essentially, just that simple: from that moment of Bremer's folly, to the present day.

However, if we look at that sequence of events with the eyes of the greatest tragedians, as, for example, Aeschylus, Shakespeare, and Friedrich Schiller, the war was already going to become lost, as lost as on the day Hamlet appeared on Shakespeare's parapet, even before Bremer's arrival. According to that principle of Classical tragedy, Bremer's arrival was in and of itself, an expression of the "fatal flaw" of a U.S.A. under the reign of the Bush-Cheney Administration. A war which had been launched by a great lie crafted by Britain's Tony Blair government, creating thus a war whose genetic characteristic spelled the future doom of a U.S.A. which allowed a continuation of that Bush Administration in which the tragedy of the U.S. in Southwest Asia (among other places) was embedded as if genetically. This, as I have so described it, is an historical singularity of the type which the greatest playwrights and historians know as tragedy. To the extent that the U.S. Congress and others submit to that factor, they become an integral part of the cause for the ensuing great tragedy which threatens the U.S. right now.

The experience should have suggested, that a little bit of competence and sanity in a sitting U.S. President, were desirable, and, also, of course, a Vice-President who knows how to shoot straight, to be picked up for the post of an elected official of the Presidency itself, by the right wife, perhaps one like U.S. Senator Hillary Clinton.

3.50 The Eurasian Land-Bridge as a Paradigm

During the interval he served as U.S. Secretary of State, the future U.S. President John Quincy Adams virtually created the U.S. State Department in its role as a functioning institution. Later, after his term as President, he served for years as a U.S. Federal Representative, where his exemplary role on many matters included his association with U.S. House member Abraham Lincoln in the matter of the famous "Spot" resolution presented as a Lincoln address to that chamber. Looking to his signal earlier accomplishments as U.S. Secretary of State, we should take into account that he was crucial in defin-

ing the future territory of the U.S. republic, as a sovereign continental republic, with fixed north and south borders within that continent, a commitment by Adams, and relevant others, on which the continued existence of our U.S.A., to the present time, has depended.

It was this commitment to the conception of the future dimensions of U.S. sovereignty which defined the objective of establishing both a system of transcontinental railroads, and of bringing armies of immigrants from Europe (most notably) to fill up and develop the western land-areas on which our emergence as a continental power, during the time of the Lincoln Presidency, and also later, depended.

3.51 *Fighting Other People's Wars*

Contrary to the essentially sentimental follies inhabiting the opinions of foolish people, during the entire span of time from February 1763, our republic's continued existence and development, has had but one constant foreign adversary, the Anglo-Dutch Liberal system, first consolidated under the virtual imperial authority established in February 1763, the imperial power of, not the British monarchy, but the neo-Venetian power of the British East India Company and its successors.

What all-too-easily fools people who are ignorant of the true principles of the history of statecraft, is the assumption that imperial powers rely entirely upon their own military and related capabilities for maintaining and expanding their imperial powers.

As the British interest demonstrated in the case of its temporary financial assistance to Frederick the Great of Prussia, in the matter of the so-called "Seven Years War," it was through that war that the Company interest, later typified by the emergence of Lord Shelburne's power, by which continental Europe was induced to weaken itself by engaging in that foolish war. This was not new at the time. The Anglo-Dutch Liberal interest associated inclusively with William of Orange, had lured a France fallen into the hands of a foolish Louis XIV into the needless wars, which Cardinal Mazarin's political heir, the great Jean-Baptiste Colbert, had warned against. At this time, France was, beyond all reasonable doubt, the most powerful state, with the most advanced scientific and economic development in all of Europe. By 1763, this had been reduced almost to a shambles by the wars orchestrated by the Anglo-Dutch Liberal heirs of Paolo Sarpi's faction.

When Athens and its allies had defeated the Persian Empire's attacking maritime and land forces, Athens had defeated those attacking forces by a brilliant demonstration of the superior maritime capabilities of the Greeks, thus outflanking the advantage of the vastly superior forces assembled by the empire on land. However, the empire had already struck back, through the spread of Sophistry against the youth and young adults of Athens by Greece's chief internal enemy, the Apollo-Dionysos cult of Delphi. The Peloponnesian War ruined Ath-

ens in the fashion later used by the British Empire to orchestrate—again, and again, and again—ruinous warfare on the continent of Europe, and into Eurasia beyond.

So, the modern form of Sophistry, called existentialism, of the Congress for Cultural Freedom and the Frankfurt School, was employed to target a certain segment of the newborn children of what came to be known as the *White Collar* and *Organization Man* classifications, especially from among those born between 1945 and 1958, to create the future base of Sophistry characteristic of the essentially anti-farmer, anti-labor, anti-scientific development, the so-called "Baby Boomer" generation.

So, the same empire, using its influential dupes among our own nation's ranks, worked to draw us into a long war in Indo-China. So, among a long list of kindred examples, the Fabians associated with Prime Minister Tony Blair, using such British patsies and Fabian ideologues as Lynne Cheney and her brutish husband, as part of a resource which has worked to wreck our United States in a worse than useless, needless war, brought about by Fabian London and its U.S. accomplices, in Southwest Asia.

Getting a targeted nation to ruin itself by being induced to fight other people's wars, especially long wars, is seen from all known history as one among the more popular ways in which an imperial power becomes, and remains an imperial power. Rather than fight a war itself, an imperial power customarily prefers to promote the warfare arranged to occur among those other nations of both the world it wishes to manage as the world it considers as part of its empire-in-fact, or at the borders of its empire-in-fact.⁵⁴

3.52 *Our American Revolution*

The so-called "British system," the Anglo-Dutch Liberal system as implicitly conceived by Paolo Sarpi, made its character and continuing intention clear in the 1763 Peace of Paris. The emergence of Lord Shelburne as chief political thug of the British East India Company, signaled that quality of change at that time, which, among its other consequences, prompted the decent folk among the English-speaking American colonists to launch the process of resistance to British tyranny out of which the U.S. Declaration of Independence was to emerge in 1776.

However, our struggle for an independent republic was not merely a revolt against the new round of a series of abuses which the Anglo-Dutch Liberal tyranny of William of Orange and his successors had begun to heap upon us since 1688-1689. The best spirits of Europe, including those in England, which had founded American colonies such as Massachusetts Bay, and others, had echoed the policy of the Fifteenth Centu-

54. The manner in which London rapes the Zimbabwe which it considers to be still, in fact, a "disobedient" part of Britain's imperial African colonies, is an example of this. What is really disgusting, is the current U.S. Bush Administration's complicity in this.

ry's Cardinal Nicholas of Cusa, to take the best achievements signaled by the great ecumenical Council of Florence across the oceans, to build up the intended cultures of a system of sovereign nations of the future.⁵⁵ This intention pulsated at sundry points in the history of the horrors experienced by modern Europe, impelling brave advocates of a true republic to places, across the oceans where the great legacy of modern European republicanism could develop the best cultural contributions of Europe at a relatively safe distance from the persistence of the titled and financier forms of European oligarchies.

The period of Queen Anne's reign had included a respite, when English-speaking patriots, including such as the English Tories of that time, were still significant as a force of organized resistance to the Liberal party of scoundrels such as William of Orange and his crew. The emergence of Benjamin Franklin as a leading political and scientific figure on both sides of the Atlantic, even in the time of the cesspool of Liberal debauchery typified by Walpole, expressed this.

Our struggle for liberty was not merely one against abuses; it was an affirmation of the existing good against the tyranny of an evil and debauched, imperial system of Liberalism, a system which had seized dominion over Britain and places elsewhere. It was a cruel and debauched Britain, which honorable men could not degrade themselves to serve. The problem was not that the people of the United Kingdom were of an evil nature; the point of the struggle was that we were obliged to defend the good, where it reigned, against the debauchery which reigned so Liberally in London.

That problem of 1763-1776 persists today.

The inherently morally depraved political form of social system which reigns in London and relevant other capitals of the world still, today, is not a creature of the British monarchy; rather, the monarchy is degraded to serve an instrument of an evil system derived from the same evil which had dominated Europe under the partnership of old medieval Venice and the Norman chivalry. In a certain sense, the Old Lady of Threadneedle Street, the Bank of England, the one which launched Adolf Hitler's rise to power in the time of Montagu Norman, those bankers and the like of that financier community, is the actually reigning Queen of today's extended Commonwealth (the present name for the political core of that empire), not the flesh-and-blood monarch, today.

It is of essential importance that any person who is permitted to become a President of our U.S.A., for example, understand this history and its associated issues very clearly, especially in this present time of global existential crisis of

55. It had been Cusa whose proposal to this effect, as to be seen in Portugal at that time, had fallen under the nose and eyes of Christopher Columbus, approximately 1480, and which thus inspired Columbus to undertake the journey across the Atlantic to the land and people on the other side. It was the great reform, overturning the evils of the Venetian-Norman tyranny, launched by Cusa et al. in the context of the organizing of the Council of Florence, which, remains to this day the proximate ancestor of our republic.

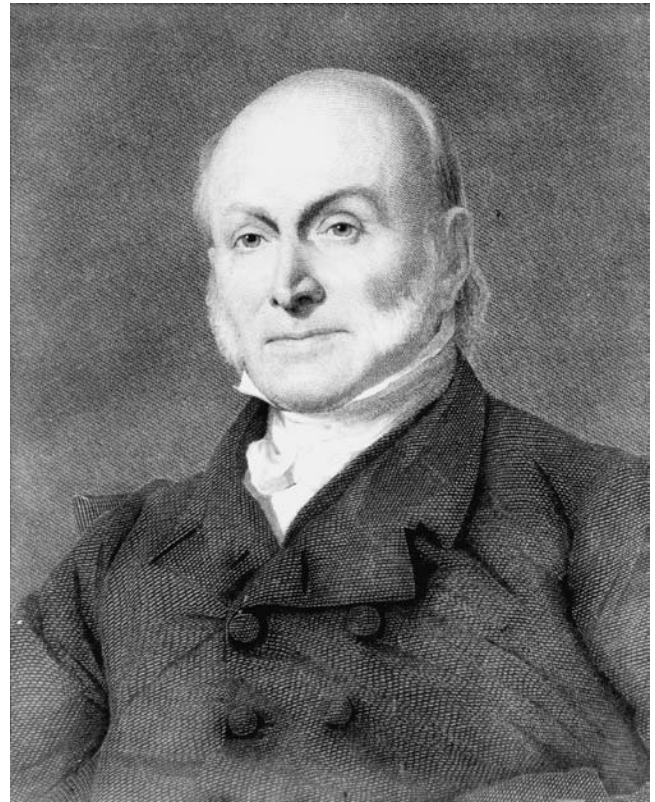

Library of Congress

John Quincy Adams, first as Secretary of State and then as President, was crucial in defining the United States as a sovereign, continental republic. Realizing this objective required establishing a system of transcontinental railroads, which began under Lincoln's Presidency.

humanity as a whole. The British Liberal system is an empire in the full sense of the use of the term "empire" to designate ancient Babylon, imperial Rome, or Byzantium. The relative distinction of the British empire, throughout its history, as under Fabian Society direction still today,⁵⁶ lies in the combination of its hereditary likeness, and differences with the empire which medieval Venice shared with the Norman chivalry. It was the Venetian financier system which actually controlled, and directed the Norman chivalry's system of crusades, an arrangement called the *ultramontane* system of imperial rule, the system reflected in Vice-President Dick Cheney's Middlebury College-based promotion of the policy of a revolution in military affairs, and also in religious warfare, the two leading policies of Samuel P. Huntington's *The Soldier and the State* and *The Clash of Civilizations*.

Like all really witting empires since the Fall of Rome, Europe-based empires often prefer to organize warfare, rather than actually fight it themselves. Usually, they fight wars only when their participation is deemed necessary to prompt the

56. Mrs. Lynne Cheney, who adopted her husband to her leash, is ideologically a Fabian. Accordingly, her brutish husband is her dog.



Russian President's website

Presidents Putin and Bush at a summit in Shanghai, China, Oct. 21, 2001. Putin's effort to achieve cooperation with Bush has nothing to do with personal affinity, but is an expression of the ties between Russia and the United States dating back to the 18th Century. An alliance among the United States, Russia, China, and India, LaRouche emphasizes, is essential for reorganizing the bankrupt world financial system.

launch of that war, as Fabian Prime Minister Tony Blair did in the case of the recent war in Southwest Asia, or in the British launching of the so-called "Great War" of 1914. In the case of World War II, Britain had expended great effort to create Hitler, and to send him eastward, before carrying out their intention of falling on Germany's rear. They had intended, earlier, to ruin the U.S.A., not serve as its ally; Franklin Roosevelt spoiled that British plan, for which reluctant ally London and its American Liberal anglophiles have Liberally hated Franklin Roosevelt, to the present day.⁵⁷

An interesting shift in the global correlation of forces has occurred since the inauguration of Vladimir Putin as the President of Russia. President Putin has returned to a point of

57. I had the occasion, once, to ask, tongue in cheek, of a relevant military figure who had once commanded Rommel's rear guard, whether or not he agreed, that the Field Marshall Montgomery otherwise to be known as a celebrated and swinish racist, were not the worst prominent commander during World War II. The reply to my query was—twenty years ago (I recall now the exact words, spoken in English) vividly: "You can not say anything bad about Montgomery to me; he saved my life. I commanded the rear guard in the retreat... If he had ever flanked me, I would be dead today." "Market Garden" was another occasion where Montgomery exhibited a comparable, high-pitched flaw in character. That doubtlessly damned fool either could not, or would not, read a map! Excellent evidence indicates that Montgomery actually was assigned to take over in both, and other occasions, because London, as we know, especially, Churchill personally, did not wish to have Anglo-American forces win the war against Hitler "prematurely."

view which, in some notable degree echoes Josef Stalin's view of the U.S.A. under President Franklin Roosevelt. President Putin's consistent efforts to find cooperation with George W. Bush, Jr.'s Presidency since that time has come to assume the character of an effort to find cooperation with the U.S.A. in world affairs, rather than representing a special attachment to President Bush, or simply an echo of Stalin's high regard for President Franklin Roosevelt. The resemblance had virtually nothing to do with Communism then, in Stalin's time, or Putin's Russia today; the ties between Russia and the U.S.A. date from such past times as the League of Armed Neutrality, diplomat John Quincy Adams's relationship to Czar Alexander I, and the policies of Russia under Czars Alexander II and Alexander III, notably including Russia's naval support for the U.S.A. during the period of the Lincoln Presidency, and the influence of Mendeleyev's promoting of those methods of the American System of political-economy which had been presented at the Philadelphia Centennial Exhibition, during the reign

of Alexander III.

The hand of fate, so to speak, shapes the current Putin posture toward the U.S.A. as a desired partner. A western and central continental Europe under London's imperial thumb is not a reliable partner for almost anyone, despite the recurring naturally strong, historical disposition of Germany, since 1812, for developing economic and other ties to Russia and to the east beyond.

President Putin is right in this choice of posture, even though its success is by no means guaranteed presently. There is an historical sort of natural disposition, based in deep and strong impulses of natural self-interest, for close cooperation between the U.S.A. and Russia. The cases referenced just above point in that direction. If the U.S.A. and Russia muster cooperation extended to the principal nations of Asia, China, and India, any sound program of cooperation in shaping world history has a great chance of success, whereas, were such cooperation lacking, solutions for any currently major problem in the world at large are most unlikely.

Without such cooperation, and short of crushing the influence of the British empire-in-fact, nothing urgently needed, which is also good, were likely to succeed, in time, at the present, critical juncture in world history. The key to this fact, is that cooperation among these four powers strips away the power of the British empire-in-fact to create "other people's wars," whether under the still ongoing Sykes-Picot cabal, or

other means. Any realistic prospect of peace in the world today, depends absolutely on the shared support of that cause by the combined influence of the U.S.A., Russia, China, and India.

3.53 Railroads and Nuclear Power

While many other developments were occurring, the world as a whole has been greatly changed in another respect. As I have emphasized earlier, British traditional geopolitics is essentially dead. The critical margin of advantage of maritime power, in the possibilities and prices of conveying relatively large and weighty masses of bulk around the world, has lost its formerly seeming attribute of strategic magic. The essential feature of geopolitics is now radically changed from the imprint of the old British Empire, of the time of Prince Edward Albert's plotting of world war, and even World War II. Geopoliticians of the old style, ironically including Haushofer in this, are now to be ridiculed as antiques, and as cheap at that.

The change goes much deeper than that. It goes very deep, and is qualitative. History could never be the same again.

As I have written here earlier, the shudder up and down the British spine, which is called "geopolitics," was started by the U.S. development of a system of transcontinental railways. Germany was confronted by the British rage of Prince Edward Albert against both President Lincoln and Chancellor Bismarck. Kaiser Wilhelm conceded readily to his uncle Prince Edward Albert's rage, and fired Bismarck. Mendeleyev's trans-Siberian railway project had also terrified London in ways expressed from 1905 onward. Germany's Berlin-to-Baghdad project was, among other considerations, a threat to the British navy's conversion of its dreadnaughts from coal-fired to oil-burning craft.

Essentially, at that point, the future which was to be called World War I, was on. "Geopolitics" became fashionable. Get railway-infested Germany and Russia to kill each other! Germany's challenge to British sea-power was a marginal threat. The threat to the British Empire from the

FIGURE 9
National Passenger Rail System Halved, 1970-2005

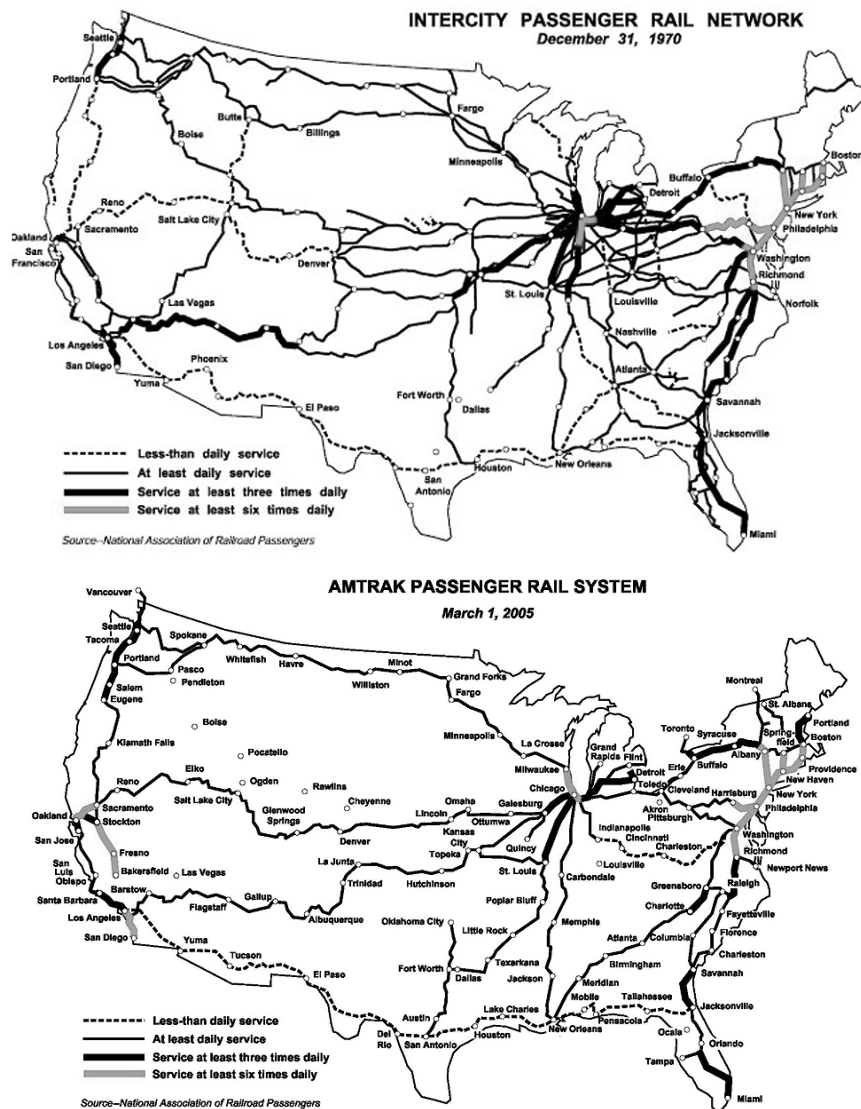

Source: National Association of Railroad Passengers; Amtrak.

Since the death of FDR, British financial interests have been determined to eliminate U.S. continental rail networks. In 1970, when Amtrak came into being, relieving freight railroads of their unwanted passenger rail services, the system's passenger route-miles had already been reduced from 88,717 miles in 1962 to the 44,020 pictured here. The Federal government and certain Wall Street "reform" advocates kept Amtrak on a starvation diet, resulting in a further takedown of the system. The 2005 map shows the remaining 21,807 route-miles left, a cut by half since 1970. Whole regions of the country are no longer served by rail, despite increased demand for rail service.

prospect of Eurasian transcontinental railway systems was rightly estimated to be awesome. After President Franklin Roosevelt, Britain and its Wall Street and related toadies, were eager to be rid of our continental railway networks as rapidly as they could find a suitable net margin of profit in doing so. So, our highways, bridges, and economy are be-

ing trucked to death, using trucking in the worst possible way.⁵⁸

That, today, has become a lesson from the past.

The crucial difference here is best illustrated by the effects of the increase of the population of Asia, and the urgent requirements for Africa. However, the net advantage is global.

The increase of world population to levels in the order of 1.4 billions for China and 1.1 for India, typifies the principal factor of required qualitative change in global policies respecting the technologies of transport and power.

The most crucial bottleneck which must be overcome is to be found in the distance between the tip of Siberia, at Uelen, Russia, and the Bering Strait coast of Alaska. A tunnel-system between those two points would implicitly link the entirety of the continent of Eurasia to the entirety of the continent of the Americas. Similar links from Southwest Asia and Europe, into Africa, would make feasible the development of an emerging magnetic-levitation network, for both freight and passengers, covering the majority of the land areas of the world in a single system. With the aid of maglev transport, as merely supplemented by ocean-borne and air freight and passenger transport, we have the prospect of the most efficient transport system possible within the remainder of the next hundred years.

This need is complemented by the urgency of replacing reliance on consumption of petroleum and related types of fuels, by hydrogen-based fuels produced by high-temperature nuclear gas-cooled reactors. The most important present correlative of that change in technology programs, is the present world crisis respecting supplies of potable fresh water. Petroleum use must be shifted into a primary use as a petrochemical feedstock for manufacturing, limiting local use of petroleum to consumption as an overflow near to the location where the extraction occurs.

We have a present problem with dependency on petroleum as a fuel, which is comparable to the terrible effects of devotion of the railway system to long-distance hauling of coal which is also better used as a production feedstock in the vicinity of the location where its extraction occurs.

To achieve what is now that urgently needed revolution in technology and economy, the Bering Strait tunnel with the associated extension of the trans-Siberian system represents the crucial bottleneck to be overcome.

58. Truck transport should be mainly limited to its role as an auxiliary of rail transport. Rail is inherently cheaper, when the system is properly organized and managed, and also much faster for medium to long distances. The loss of a functional transcontinental network is a major contributing cause for the economic crisis in regional air transport, especially when the speed of magnetic levitation (circa 300 mph) is weighed against the inherently much greater costs of short- to medium-range air transport. Trucking has an advantage for local transport, and traditional modern rail over regional air transport. The inherent technological and economic advantage of maglev over regional air, for both freight and passenger transport, is enormous.

3.60 Thermonuclear Fusion

There is a third leading consideration, which shifts our horizon to a point beyond nuclear-fission resources: the growth of the world's population, especially in Asia recently.

This is not a matter of quantity, but of quality. The strategic implication of today, which is largely a consequence of the growth of the world's population, the growth of population in major nations of Asia, most notably, is the increased level of global requirements for essential raw materials. This increase is driven not only by the increase of the population. It is driven much more by the immediate need for the improved standard of living required to lift the greater mass of the world's already existing population-levels.

This challenge can be met, but it requires a change in the way we think about raw materials. We must abandon the idea of reliance upon extraction, and shift emphasis increasingly to production, rather than extraction.

This change presents us with two kinds of leading challenges which we are obliged to begin building into our standard notions of economy right now.

3.70 Reverse Nixon's Health-Care Policy

During World War II, the United States had deployed a system of health care and closely related functions, programs, and facilities, whose achievements in that mission for more than 16 millions in service, provided the model for extension of the lessons learned in warfare to the design of a national programmatic policy within the republic at large, and among the Federal states and their localities, which served the nation with relative excellence and constant improvements, under a policy expressed as a piece of Federal legislation known as Hill-Burton.

Hill-Burton was destroyed under the Nixon Administration. That began a long wave of deterioration of the quality and accessibility of health care to the nation, its localities, its citizens, and also its military over the recent period of approximately thirty-five years.

Given the capabilities of a scientifically, technologically progressive form of modern nation-state, a high quality of health care assumes the character of a natural right of the member of society, such that, as the experience of Hill-Burton had shown prior to its repeal, it is feasible to provide the health care required, with no obligation of the beneficiary other than a reasonable contribution according to his or her family's ability to pay within his or her family's means.

Under the changed conditions in the economy, and other factors, the repeal of Hill-Burton has been transformed into a source of financial bonanzas, not only at the expense of the physician, nurse, and other health-care professionals, and of related institutions required for the delivery of this care, but at a soaring profit to insurance companies and others who milk the system and the population dry from the non-medical-professional financial apparatus squatting and sucking away on top.

Relative to the trend in mean income of the household, the cost of care and medication soars. Until the onset of the recently unleashed global financial crisis, we observe the seeming statistical miracle that while the golden parachutes of the non-medical overseer organizations have soared miraculously ever higher, the care for the patient and support for the physician continue to fall.

A return to the proven principles of Hill-Burton must be effected by aid of emergency legislation, pending later improvements which do not lessen, but enhance the quality of performance which the system delivers.

3.71 While there is now increasing, and proper concern for the financial aspects of health-care programs, corrective measures must consider the organization of the health-care system. The most efficient care for the population is designed to meet the requirements of the citizen, rather than the particular disease or related relevant condition which his body has chosen to present for care. The great effort and successes which the preferred institution of the population-oriented general hospital and polyclinic were designed to provide the community, instead of a particular brand of disease, tend to vanish as a superimposed financial bureaucracy's increasingly speculative profit-augmentation orientation has taken over more and more of the field of customary practice, that in a fashion suggestive of something overrun by a giant slime-mold. The shrinking of health-care capacity is even far less the root-cause of major problems, than, itself, the effect of denial of access to health-care by ever-increasing percentiles of the population, and the inclination, by the George W. Bush, Jr. Administration, to increase the death-rate among our citizens (and soldiers), rather than care for the sick and aged.

It is necessary to bring all health-care related policy under the same orientation expressed by the intention of military health care which was provided by our government under World War II conditions. Times change, technologies change, man's currently popular diseases change, professionals' abilities evolve, and new diseases are to be considered, but human individuals and the societies composed of them persist in their traditional design of the individual human being.

3.80 The Murderous Lunacy of Globalization

The essential distinction of the human individual from any lower form of life, is the power of reason. At bottom, the edifice of reason in society, as expressed in terms of the sovereignty of the individual human mind, is mediated through the implications of the development of the character of the ironies of implication associated with the use for communication of a customary language, and the specific traits of culture associated with that individual in his or her society. If society attempts to wrest the individual's use of language from the ironies which are associated with, but not contained within a dictionary kind of notion of a language's literal meanings, including the rela-

tively more sophisticated modes of scientific progress and Classical artistic expression, the creative powers of the human individual are habitually damaged by their absence from communications, even virtually destroyed as a matter of habit.

So, it is the role of irony in a language, as most readily accessible to observation in its great Classical poetry, not the imputable dictionary meaning of terms, which is the medium in which the communication of the creative powers of the individual mind is conveyed.

For example, to the extent that the use of digital computers is kept in conformity with so-called "logic," computers can not communicate ideas explicitly by logic. Actual ideas are transmitted, not by formal logic, but only by means of the quality of ambiguity represented by Classical irony, as by "performing between the notes." Important ideas, as typified otherwise by the act of a discovery of a universal physical principle, such as Johannes Kepler's uniquely original discovery of universal gravitation, are communicated only by that specific quality of ironical implication, whether in physical science, in Classical poetry and drama, or, in Classical musical composition and its appropriate performance.

The Classical poet, for example, appeals to the ironical potentialities implicitly associated with the uses of a specific language, or by a pun which relies for its ironical meaning on a relevant incongruity produced by the juxtaposition of two contrasted languages, or forms of their usages.

Hence, on the basis of such evidence from experience, we nod in sympathy (and also satisfaction) at the Biblical account of the destruction of the Tower of Babel. The Creator must have been extraordinarily angry on that occasion, and decent men and women must agree with that Heavenly sentiment.

Globalization is suited only for slaves who might be contented with remaining slaves, or have no visible option of being anything else. If they choose globalization, then, they will be slaves.

The Epilogue

The nearest recent example of an experience of the kind of sweeping change in the reigning cultural paradigm of the people urgently needed by our U.S.A. today, is that change which came about during the interval between the 1929 "Crash" and the first inauguration of President Franklin D. Roosevelt. Unless an echo of that quality of turnabout in leadership begins to occur at an accelerating rate, during in the immediate weeks to come, it is certain that the security, perhaps even the existence of the republic under our present Constitution, might not continue into a time of as early as the presently scheduled next general election.

As subsequent developments showed, the change which history records as having occurred in this fashion, during and following 1932-1933, was possible because the majority among the U.S. population had then recognized a sense of the

Four Signal Developments of the Post-2004 Election Period



EIRNS/Stuart Lewis

House Speaker Nancy Pelosi and Senate Majority Leader Harry Reid lead a press conference of Congressional Democrats in defense of Social Security, April 27, 2005.



EIRNS/Elizabeth Mendel

The LaRouche Youth Movement organizes to dump Dick Cheney, in Oakland, Calif. The LYM's nation-wide campaign has sparked the demand by an overwhelming majority of U.S. citizens to impeach Cheney.



White House/Eric Draper

President Bush addresses the nation in New Orleans, Sept. 15, 2005, after Hurricane Katrina. After his speech, the generators used to provide power for the lights used to film him, were removed: a metaphor for the President's brutish indifference to the people of New Orleans.



Interstate 35W's Aug. 1, 2007 collapse over the Mississippi River, in Minneapolis, Minn., awoke many Americans to the urgency of dealing with the nation's collapsing physical economic infrastructure.

history and values of our U.S.A. which was already deeply embedded within them, but which had been concealed from view, that prior to the reverberating effects of the 1929 Crash itself, under the surface of a contrary, apparent, current day-to-day opinion.

As the customary tragedies of populism attest, successful political deceit, as in our nation's experience of the recent years, is the art otherwise typical of the pimp, or prostitute alike. Such folk take pleasure in getting the diseases they may

share, because, like the gamblers which they are at heart, they preferred their passions of the moment, to the needed decisions on which the future welfare of society as a whole depends: decisions which they, for the sake of comfort, had preferred to avoid.

The paradoxes arising as expressions of a conflict between an underlying long-term interest, even an interest in survival, and relatively short-term perception of immediate, narrow advantage, has often been the stuff of which the choice between

tragedy and victory is made. This is the stuff of which the issues of true leadership in statecraft are composed.

Four typical recent illustrations of the same, relevant principle of sociology which such developments reflect, came into view, following the 2004 general election. These were reflections of certain among the developments which had already occurred under the Presidency of George W. Bush, Jr., even prior to the 2004 general election:

First, the reaction, among the U.S. population of 2005, and among a crucially significant part of the leadership of the Democratic Party in the U.S. Congress then, respecting the need to rally to defend the institution of Social Security against the thieving rapacity of President George W. “they are only promises made by government” Bush.

Second, the reaction of the majority of the members of the Senate, during that same year, to President George W. Bush’s brutish indifference to the horrendous realities of Hurricane Katrina.

Third, the rejection by the Democratic Party leadership, of a growing demand for the immediate ouster of Vice-President Dick Cheney, a demand by what is presently an overwhelming, perceptive majority of the U.S. citizens: citizens who are determined to end the current wasting warfare which the incumbent U.S. Presidency is continuing to wage in Southwest Asia, under the prompting of Cheney’s and President Bush’s adoption of Alexander Helphand’s Fabian flag of “permanent warfare, permanent revolution.”

Fourth, the general reaction to the President’s expressed indifference to the lesson of the collapse of the Minneapolis I-35W highway bridge across the Mississippi River.

This President has liked to get money, especially from those his policies made poor and helpless, but never to actually earn it.

When we take those four signal social facts into account, there is a terrible prospect now afoot.

Seeing the case of the issue between the Hoover Administration and President Roosevelt’s 1932 candidacy, we should be reminded now of what had just happened during January-February 1933 in Germany, when a party then enjoying the support of a no more than a restive minority of the population, was installed as what became in rapid fire, between the end of January and late February, a terrible dictatorship of Adolf Hitler from which the Germany population could not free its will, until Hitler was dead in 1945.

Then, in those early 1930s, the foolish reaction of both the political majority of the parties, and, also, the Reichswehr leadership’s abandonment of the defense of the existence and honor of both its institution and its nation, expressed the widespread negligence which had been fostered through over-confidence in the fact that the Hitler party was only a minority.

Similar voices today say, “But Cheney is only the Vice-President,” or, more plausibly, the President of Vice. A change which occurred that same month of February 1933, an event like our own September 11, 2001 experience, the burning of



Hitler at a Nazi rally in Nuremberg, circa 1928. Most political and military leaders in Germany thought the pro-Hitler forces were “only a minority,” and would never amount to a serious threat. Similar voices today say, “But Cheney is only the Vice-President”—and ignore the march toward tyranny of a powerful minority at the top.

the Reichstag under the direction of Hermann Göring, put Hitler into power over the very bodies of many of the foolish political opponents of a Hitler dictatorship. These were opponents of Hitler who had bravely and boldly clung to their refusal to take the thoroughly documented immediacy of the Nazi threat seriously, just as a leading layer in the Democratic Party’s leadership, has acted lately with a similar indifference to a terrible, onrushing reality which they might have changed.

There will be, ultimately, no forgiveness by the ongoing processes of history, for those in positions of power, who had refused to act to prevent what reasonable people in power should have foreseen as a looming threat of historical, and horrible dimensions to the general welfare of their nation or alliance. The punishment for such negligence, were it to persist, would assuredly be delivered, in Fate’s own choice of time and penalty alike.

Something like that which happened in Germany, over the interval from the hyperinflationary spiral of 1923 through the death of Hitler in 1945, could happen, even in the U.S.A.,

and elsewhere, even now, under present conditions in the on-rolling, gravest world monetary-financial crisis of the planet since 1929-1933.

The essence of the recurring threat of dictatorship in modern European history, has been the failure of relevant leading institutions to muster a timely response in defense of the imperiled self-interest of the majority of a people. This is the kind of a failure which has created, again and again, the opportunity for the establishment of the tyranny by a powerful minority near the top. This kind of tragic development usually reflects a conflicting set of dynamics, as I have presented the case for dynamics here: a conflict between the long-term reality of a people's actual interest, and the failure to mobilize a majority which would defend society against a usurping minority like that associated with Vice-President Cheney and London's relevant Fabians of today.

Lately, the leadership of the Democratic Party, having entered a time of the gravest existential crisis of our republic since that of 1929-1933, has reacted, so far, like the German Social-Democrats, and others, of 1928-1933. It has capitulated, again and again, as since the beginning of 2006, to the on-rushing, transparently clear preparations by trans-Atlantic circles associated with the war party of Vice-President Cheney and former Prime Minister Tony Blair, for the establishment of dictatorship and permanent war. This has been a net failure of that leadership, like that of the German Social-Democracy of early 1933, the failure to respond with any decency, to the deep and obviously immediate threat to the true interests of the majority of our people and their society's institutions.

Now, as in 1929-1933, the popularly reflected impulse of our nation's long-term institutions, is to overturn the long-term disaster brought about through continuation of present trends in economic and social practice of our institutions; the impulse to act in support of the popular expression of our true national interest; and, to act in opposition to the continuation of ruinous war concocted by the concurrence of our incumbent government's deceit with its leading opposition's cowardly Sophistries.

The time has come, now, when the Democratic Party's leadership must recognize its moral obligation to abandon its recent opposition to the political base's clearly expressed and righteous demand for the immediate ouster of Vice-President Cheney. The Party's leadership must acknowledge the truth, that the Party and perhaps the nation, too, would rot in ruins for a generation or more to come, if it were to fail to act as that great majority now demands. A refusal to launch this change would be catastrophic, as catastrophe were measured in the price to be paid by the nation, as happened in the exemplary case of the parties which failed to prevent the Hitler regime when that might still have been done.

The lesson to be learned is, that Hitler did not create himself, but that men and women like the head of the Bank of England, and powerful New York and London financier interests actually pushed Hitler into power, including a Hjalmar

Schacht who was charged, but never convicted for his crimes on this account. It is not the storm troopers who need to be feared, but the powerful financiers who use the Mussolinis, Hitlers and their like.

Right now, as I write, much of the incumbent party leadership has been wrong, while the party's pre-Presidential primary campaign is, so far, looming as an early disaster of epic existential implications. Will sufficient portions of the recognized leadership layers within that party rally right now, agree to change their ways, to turn themselves around and provide the kind of leadership of economy and in the matter of war versus peace which a presently overwhelming majority of the population as a whole, now rightly demands? In other words, will the specter of Presidential candidate Franklin D. Roosevelt be heard and heeded within the relevant hallways of incumbent political power?

END NOTE

Chorus:

O for a Muse of fire, that would ascend
The brightest heaven of invention,
A kingdom for a stage, princes to act
And monarchs to behold the swelling scene!
Then should the warlike Harry, like himself,
Assume the port of Mars; and at his heels,
Leash'd in like hounds, should famine, sword and fire
Crouch for employment. But pardon, and gentles all,
The flat unraised spirits that have dared
On this unworthy scaffold to bring forth
So great an object: can this cockpit hold
The vasty fields of France? or may we cram
Within this wooden O the very casques
That did affright the air at Agincourt?
O, pardon! since a crooked figure may
Attest in little place a million;
And let us, ciphers to this great accompt,
On your imaginary forces work.
Suppose within the girdle of these walls
Are now confined two mighty monarchies,
Whose high upreared and abutting fronts
The perilous narrow ocean parts asunder:
Piece out our imperfections with your thoughts;
Into a thousand parts divide on man,
And make imaginary puissance;
Think when we talk of horses, that you see them
Printing their proud hoofs i' the receiving earth;
For 'tis your thoughts that now must deck our kings,
Carry them here and there; jumping o'er times,
Turning the accomplishment of many years
Into an hour-glass: for the which supply,
Admit me Chorus to this history;
Who prologue-like your humble patience pray,
Gently to hear, kindly to judge, our play.

—Henry V, Act 1, Prologue